

# USER MANUAL



SHOOT WOW!  
SHARE NOW!



## NX1

**ENG** This user manual includes detailed usage instructions for your camera. Please read this manual thoroughly.

# Copyright information

---

- Microsoft Windows and the Windows logo are registered trademarks of the Microsoft Corporation.
- Mac and Apple App Store are registered trademarks of the Apple Corporation.
- Google Play Store is a registered trademark of Google, Inc.
- Adobe, the Adobe logo, Photoshop, and Lightroom are either registered trademarks or trademarks of Adobe Systems Incorporated in the United States and/or other countries.
- SD™, SDHC™, and SDXC™ are registered trademarks of the SD Association.
- HDMI, the HDMI logo, and the term “High Definition Multimedia Interface” are trademarks or registered trademarks of HDMI Licensing LLC.
- Bluetooth® is a registered trademark of Bluetooth SIG, Inc. worldwide.
- Wi-Fi®, the Wi-Fi CERTIFIED logo, and the Wi-Fi logo are registered trademarks of the Wi-Fi Alliance.
- ATOMOS is a registered trademark of ATOMOS Pty Ltd.
- Trademarks and trade names used in this manual are the property of their respective owners.



- Camera specifications or contents of this manual may be changed without prior notice due to upgrade of camera functions.
- You are not allowed to reuse or distribute any part of this manual without prior permission.
- We recommend using your camera within the country where you purchase it.
- Use this camera responsibly and adhere to all laws and regulations concerning its use.
- This manual is for NX1 cameras with firmware version 1.20 or later.



PlanetFirst represents Samsung Electronics' commitment to sustainable development and social responsibility through eco-driven business and management activities.

# Health and safety information

---

Always comply with the following precautions and usage tips to avoid dangerous situations and ensure peak performance of your camera.



**Warning—situations that could cause injury to yourself or others**

## **Do not disassemble or attempt to repair your camera.**

You can damage the camera and expose yourself to the risk of an electric shock.

## **Do not use your camera near flammable or explosive gases and liquids.**

This may cause a fire or explosion.

## **Do not insert flammable materials into the camera or store these materials near the camera.**

This may cause a fire or electric shock.

## **Do not handle your camera with wet hands.**

This may result in an electric shock.

## **Prevent damage to subjects' eyesight.**

Do not use the flash in close proximity (closer than 1 m/3 ft) to people or animals. If you use the flash too close to your subject's eyes, this can cause temporary or permanent eyesight damage.

## **Keep your camera away from small children and pets.**

Keep your camera and all accessories out of the reach of small children and animals. Small parts may cause choking or serious injury if swallowed. Moving parts and accessories may present physical dangers as well.

## **Do not expose the camera to direct sunlight or high temperatures for an extended period of time.**

Prolonged exposure to sunlight or extreme temperatures can cause permanent damage to your camera's internal components.

## **Avoid covering the camera or charger with blankets or clothes.**

The camera may overheat, which may distort the camera or cause a fire.

## **Do not handle the power supply cord or the charger during a thunderstorm.**

This may result in an electric shock.

**If liquid or foreign objects enter your camera, immediately disconnect all power sources, such as the battery or charger, and then contact a Samsung service center.**

**Comply with any regulations that restrict the use of a camera in a certain area.**

- Avoid interference with other electronic devices.
- Turn off the camera when in an aircraft. Your camera can cause interference with aircraft equipment. Follow all airline regulations and turn off your camera when directed by airline personnel.
- Turn off the camera near medical equipment. Your camera can interfere with medical equipment in hospitals or health care facilities. Follow all regulations, posted warnings, and directions from medical personnel.

**Avoid interference with pacemakers.**

Maintain a safe distance between this camera and all pacemakers to avoid potential interference, as recommended by the manufacturer and research groups. If you have any reason to suspect that your camera is interfering with a pacemaker or other medical device, turn off the camera immediately and contact the manufacturer of the pacemaker or medical device for guidance.



**Caution—situations that could cause damage to your camera or other equipment**

**Remove the batteries from your camera when storing it for an extended period of time.**

Installed batteries may leak or corrode over time and cause serious damage to your camera.

**Use only authentic, manufacturer-recommended, Lithium-ion replacement batteries. Do not damage or heat the battery.**

Inauthentic, damaged, or heated batteries may cause a fire or personal injury.

**Use only Samsung-approved batteries, chargers, cables, and accessories.**

- Using unauthorized batteries, chargers, cables, or accessories can cause batteries to explode, damage your camera, or cause injury.
- Samsung is not responsible for damage or injuries caused by unapproved batteries, chargers, cables, or accessories.

**Use the battery only for its intended purpose.**

Misusing the battery may cause a fire or electric shock.

**Do not touch the flash while it fires.**

The flash is very hot when fired and may burn your skin.

**When you use the AC charger, turn off the camera before you disconnect the power to the AC charger.**

Failing to do so may result in fire or electric shock.

**Disconnect the charger from the wall socket when not in use.**

Failing to do so may result in fire or electric shock.

**Do not use a damaged power supply cord, plug, or loose outlet when you charge batteries.**

This may cause a fire or electric shock.

**Do not allow the AC charger to come in contact with the +/- terminals on the battery.**

This may cause a fire or electric shock.

**Do not drop or subject the camera to strong impacts.**

Doing so may damage the screen or external or internal components.

**Exercise caution when you connect cables and install batteries and memory cards.**

If you force the connectors, improperly connect cables, or improperly install batteries and memory cards, you can damage ports, connectors, and accessories.

**Keep cards with magnetic strips away from the camera case.**

Information stored on the card may be damaged or erased.

**Never use a damaged battery or memory card.**

This may result in electric shock or camera malfunction or cause a fire.

**Do not place the camera in or near magnetic fields.**

Doing so may cause the camera to malfunction.

**Do not use the camera if the screen is damaged.**

If the glass or acrylic parts are broken, visit a Samsung service center to have the camera repaired.

**Check that the camera is operating properly before use.**

The manufacturer takes no responsibility for any loss of files or damage that may result from camera malfunction or improper use.

**You must plug the small end of the USB cable into your camera.**

If the cable is reversed, it may damage your files. The manufacturer is not responsible for any loss of data.

**Do not expose the lens to direct sunlight.**

This may discolor the image sensor or cause it to malfunction.

**If the camera overheats, remove the battery and allow it to cool down.**

- Prolonged usage of the camera may overheat the battery and raise the internal temperature of the camera. If the camera stops operating, remove the battery and allow it to cool down.
- High internal temperatures may result in noise in your photos. This is normal and does not affect your camera's overall performance.

**Avoid interference with other electronic devices.**

Your camera emits radio frequency (RF) signals that may interfere with unshielded or improperly shielded electronic equipment, such as pacemakers, hearing aids, medical devices, and other electronic devices in homes or vehicles. Consult the manufacturers of your electronic devices to solve any interference problems you experience. To prevent unwanted interference, use only Samsung-approved devices or accessories.

**Use your camera in the normal position.**

Avoid contact with your camera's internal antenna.

**Data transference and your responsibilities**

- Data transferred via WLAN can be stolen, so avoid transferring sensitive data in public areas or on open networks.
- The camera manufacturer is not liable for any data transfers that infringe on copyrights, trademarks, intellectual property laws, or public decency ordinances.

### Bluetooth precautions

- The manufacturer is not responsible for the loss, interception, or misuse of data sent or received via the Bluetooth feature.
- Always ensure that you share and receive data with devices that are trusted and properly secured. If there are obstacles between the devices, the operating distance may be reduced.
- Some devices, especially those that are not tested or approved by the Bluetooth SIG, may be incompatible with your device.
- Do not use the Bluetooth feature for illegal purposes (for example, pirating copies of files or illegally tapping communications for commercial purposes). The manufacturer is not responsible for the repercussion of illegal use of the Bluetooth feature.
- Do not connect to Bluetooth speaker, headphones, or other accessories.





### Precautions when using the camera

- Do not expose the camera to water.
- Avoid removing or changing the lens in dusty areas.
- Ensure that the covers for the battery chamber, memory card, or external connector ports are tightly closed.
- This product is not water or dust proof. Exposure to severe conditions is not recommended. Take care when opening and closing the covers to avoid damaging the rubber seal.



# Indications used in this manual

---

## Icons used in this manual

Icon	Function
	Additional information
	Safety warnings and precautions
[ ]	Camera buttons. For example, [ <b>Shutter</b> ] represents the shutter button.
( )	Page number of related information
→	The order of options or menus you must select to perform a step; for example: Select  → <b>Quality</b> (represents select  , and then <b>Quality</b> ).
*	Annotation

## Mode indications

Mode	Indication
Auto	
Program	P
Aperture Priority	A
Shutter Priority	S
Manual	M
Custom1	C <sub>1</sub>
Custom2	C <sub>2</sub>
Smart	



# Contents

---

## Tips

### Concepts in Photography

<b>Shooting postures</b> .....	<b>14</b>
Holding the camera .....	14
Standing photography .....	14
Crouching photography .....	15
Using the display .....	15
Low-angle shot.....	16
High-angle shot.....	16
<b>Aperture</b> .....	<b>17</b>
Aperture value and the depth of field .....	18
<b>Shutter speed</b> .....	<b>19</b>
<b>ISO sensitivity</b> .....	<b>20</b>
<b>How the aperture setting, shutter speed, and ISO sensitivity control exposure</b> .....	<b>21</b>
<b>Correlation between focal length, angle, and perspective</b> .....	<b>22</b>
<b>Depth of field</b> .....	<b>23</b>
What controls out-of-focus effects?.....	23
DOF preview.....	25
<b>Composition</b> .....	<b>25</b>
Rule of Thirds.....	25
Photos with two subjects .....	26
<b>Flash</b> .....	<b>27</b>
Flash guide number.....	27
Bounce Photography .....	28

## Chapter 1

### My Camera

<b>Getting started</b> .....	<b>30</b>
Unpacking.....	30
<b>Camera layout</b> .....	<b>31</b>
Using the EVF button.....	36
<b>Inserting the battery and memory card</b> .....	<b>37</b>
Inserting the battery .....	37
Inserting a memory card .....	37
Removing the battery and memory card .....	38
Using the memory card adapter.....	38
<b>Charging the battery and turning on your camera</b> .....	<b>39</b>
Charging the battery.....	39
Turning on your camera .....	40
<b>Performing the initial setup</b> .....	<b>41</b>
<b>Selecting functions (options)</b> .....	<b>43</b>
Using buttons and dials.....	43
Using custom buttons and dials .....	43
Selecting by touch .....	44
Using MENU .....	45
E.g. Selecting the photo size in P mode.....	45
Using the smart panel .....	46
E.g. Adjust the exposure value in P mode.....	46
Using iFn.....	48

<b>Display icons .....</b>	<b>50</b>
In Shooting mode .....	50
Capturing photos .....	50
Recording videos .....	52
About the level gauge .....	53
In Playback mode .....	54
Viewing photos .....	54
Playing videos .....	54
Changing the information displayed .....	55
Viewing the status display window .....	56
Capturing photos or recording videos .....	56
Connecting to a computer .....	56
Charging batteries .....	56
Viewing the notification panel .....	57
<b>Lenses .....</b>	<b>58</b>
Lens layout .....	58
Locking or unlocking the lens .....	59
Using the Custom Focus Range Limiter Function .....	61
Lens markings .....	62
<b>Accessories .....</b>	<b>63</b>
External flash layout .....	63
Connecting the external flash .....	65
Vertical grip layout .....	66
Inserting the battery .....	67
Attaching to the camera .....	67
Battery charger .....	69
Charging the battery .....	69

<b>Shooting modes .....</b>	<b>70</b>
<b>AUTO</b> Auto mode .....	70
P Program mode .....	72
Program Shift .....	73
Minimum shutter speed .....	73
A Aperture Priority mode .....	74
S Shutter Priority mode .....	75
M Manual mode .....	76
Using the Bulb function .....	76
<b>C1 C2</b> Custom mode .....	77
Saving custom modes .....	77
Downloading custom modes .....	78
Selecting custom modes .....	78
Deleting custom modes .....	78
<b>S</b> Smart mode .....	79
Capturing panoramic photos .....	81
Using the Samsung Auto Shot mode .....	82
Recording a video .....	84
3D mode .....	86
Available functions by shooting mode .....	87

## Chapter 2

# Shooting Functions

<b>Size and Resolution .....</b>	<b>89</b>
Photo size .....	89
Quality .....	90
<b>ISO sensitivity .....</b>	<b>91</b>
Customizing ISO settings .....	92

<b>OLED Color</b> .....	<b>93</b>	<b>Drive (shooting method)</b> .....	<b>110</b>
<b>White Balance</b> .....	<b>94</b>	Single .....	111
Customizing preset White Balance options .....	95	Continuous .....	111
<b>Picture Wizard (photo styles)</b> .....	<b>96</b>	Timer .....	112
<b>Smart Filter</b> .....	<b>97</b>	Auto Exposure Bracketing (AE Bracket) .....	112
<b>AF mode</b> .....	<b>98</b>	White Balance Bracketing (WB Bracket) .....	113
Single AF .....	99	Picture Wizard Bracketing (P Wiz Bracket) .....	113
Continuous AF .....	99	Depth Bracketing .....	114
Active AF .....	100	Bracketing settings .....	114
Manual focus .....	100	<b>Interval Capture</b> .....	<b>115</b>
<b>AF area</b> .....	<b>101</b>	<b>Flash</b> .....	<b>116</b>
Selection AF .....	101	Reducing the red-eye effect .....	117
Saving Selection AF position .....	102	Using the built-in flash .....	117
Multi AF .....	102	Adjusting the flash intensity .....	118
Face Detection AF .....	103	Flash settings .....	119
Self-Portrait AF .....	103	Setting external flash .....	119
<b>Touch AF</b> .....	<b>104</b>	Setting wireless sync for internal or external flash .....	120
Touch AF .....	104	Locking the flash intensity .....	121
AF Point .....	104	<b>Metering</b> .....	<b>122</b>
Tracking AF .....	104	Multi .....	122
One touch shot .....	105	Center-weighted .....	123
<b>Focus assist</b> .....	<b>106</b>	Spot .....	123
MF Assist .....	106	Measuring the exposure value of the focus area .....	124
DMF (Direct Manual Focus) .....	107	<b>Dynamic Range</b> .....	<b>125</b>
Setting DMF responsiveness .....	107	<b>Exposure compensation</b> .....	<b>126</b>
AF Release Priority .....	107	Using Framing Mode .....	126
Focus Peaking .....	108	Viewing the overexposure guide .....	127
<b>Optical Image Stabilization (OIS)</b> .....	<b>109</b>	Using the brightness adjustment guide .....	127
		<b>Exposure/Focus lock</b> .....	<b>128</b>

<b>Exposure/Focus separation.....</b>	<b>129</b>
<b>Video functions .....</b>	<b>130</b>
Movie size.....	130
When Video Out is set to NTSC.....	130
When Video Out is set to PAL .....	131
Movie quality .....	131
Bit rates for movie sizes .....	132
Fast / Slow Movie.....	133
Gamma Control.....	133
Adjusting the settings.....	134
Master Black Level.....	134
Luminance Level.....	134
AF Responsiveness .....	135
AF Shift Speed .....	135
Fader .....	136
Voice.....	136
Wind Cut.....	136
Mic Level.....	137
Smart Range+ .....	137
Time Code (HDMI).....	137

### Chapter 3

## Playback/Editing

<b>Searching and managing files.....</b>	<b>139</b>
Viewing photos .....	139
Viewing image thumbnails.....	139
Viewing files by category .....	140

Viewing continuous shots.....	141
Protecting files .....	142
Lock/Unlock all files .....	142
Deleting files .....	143
Deleting a single file .....	143
Deleting multiple files.....	143
Deleting all files.....	143
<b>Viewing photos.....</b>	<b>144</b>
Enlarging a photo .....	144
Viewing a slide show.....	145
Viewing the overexposure guide .....	146
Viewing interval shots.....	146
Sorting files.....	146
Auto rotating .....	146
Converting to JPEG.....	146
<b>Playing videos.....</b>	<b>147</b>
Scanning backward or forward.....	147
Adjusting the brightness of a video .....	148
Adjusting the volume of a video .....	148
Trimming a video during playback.....	149
Capturing an image during playback.....	149
<b>Editing photos .....</b>	<b>150</b>
Cropping a photo.....	150
Rotating a photo .....	151
Resizing photos.....	151
Adjusting your photos.....	152
Retouching faces.....	152
Applying Smart Filter effects.....	153

**Chapter 4**

**Connecting & Transferring**

**Connecting to a smart phone..... 155**

- Using the NFC Feature..... 155
  - Using NFC features in Shooting mode..... 155
  - Using NFC features in Playback mode (Photo Beam) ..... 155
- Using the GPS Geo Tagging Feature..... 155
- Sending files to a smart phone ..... 156
- Controlling the camera remotely with a smart phone ..... 158
- Using a smart phone as a remote shutter release..... 160
- Saving files to a smart phone automatically ..... 161

**Sending photos via email..... 163**

- Connecting to a WLAN..... 163
  - Setting network options..... 164
  - Manually setting the IP address ..... 164
- Using the login browser..... 165
- Network connection tips..... 166
- Entering text ..... 167
- Sending photos via email..... 168
  - Storing a sender’s information..... 169
  - Setting an email password..... 170
  - Changing the email password ..... 171

**Viewing photos or videos on a TV ..... 172**

- Connecting wirelessly ..... 172
- Connecting via cable ..... 174
  - Viewing files on a TV..... 174
  - Viewing files on a 3D TV ..... 175

**Connecting to a computer ..... 176**

- Using Auto Backup for photos or videos..... 176
  - Installing the program for Auto Backup on your PC..... 176
  - Using the Auto Backup feature..... 176
- Connecting the camera as a removable disk ..... 178
  - Transferring files to your Windows OS computer ..... 178
  - Disconnecting the camera (for Windows 7)..... 179
  - Transferring files to your Mac OS ..... 180

**Chapter 5**

**Camera settings menu**

**User settings..... 182**

- Manage Custom Mode..... 182
- Noise Reduction ..... 182
- Color Space..... 183
- Distortion Correct ..... 184
- User Display..... 184
- Grid Line ..... 184
- Center Marker ..... 185
- Key Mapping..... 185
  - AEL ..... 185
  - AF ON ..... 186
  - Custom Wheel..... 187
  - Command Dial..... 187
  - Command Dial Direction ..... 187
  - Video Recording / MOBILE ..... 188
  - AF ON / AEL..... 188
  - Preview button/Navigation button/Delete button..... 189

iFn Customizing .....	190
Lens Button Speed Settings .....	190
Touch Operation.....	190
AF Lamp.....	190
E-Shutter.....	191
MobileLink/NFC Image Size .....	191
<b>Setting .....</b>	<b>192</b>

## Chapter 6

# Appendix

<b>Error messages .....</b>	<b>199</b>
<b>Maintaining the camera.....</b>	<b>200</b>
Cleaning the camera .....	200
Camera lens and display .....	200
Image sensor .....	200
Camera body.....	200
Using or storing the camera.....	201
Inappropriate places to use or store the camera .....	201
Using on beaches or shores.....	201
Storing for extended period of time.....	201
Using the camera with caution in the humid environments.....	202
Other precautions .....	202

About memory cards .....	203
Supported memory cards .....	203
Memory card capacity .....	204
Cautions when using memory cards.....	206
About the battery .....	207
Battery specifications.....	207
Battery life .....	208
Low battery message .....	208
Notes about using the battery.....	208
Battery precautions.....	209
Notes about charging the battery.....	209
Notes about charging with a computer connected.....	210
Handle and dispose of batteries and chargers with care.....	210
<b>Using programs on a PC.....</b>	<b>211</b>
Installing i-Launcher or i-Launcher Web.....	211
Using i-Launcher or i-Launcher Web.....	213
Opening i-Launcher.....	213
Available programs .....	213
Requirements.....	214
Installing Adobe Photoshop Lightroom .....	215
Using Adobe Photoshop Lightroom .....	215
<b>Updating the firmware.....</b>	<b>216</b>
<b>Before contacting a service center .....</b>	<b>218</b>
<b>Camera specifications .....</b>	<b>221</b>
<b>Glossary.....</b>	<b>226</b>
<b>Optional accessories.....</b>	<b>232</b>
<b>Index .....</b>	<b>233</b>

# Concepts in Photography

## Shooting postures

A correct posture for stabilizing the camera is necessary for taking a good photo. Even if you hold a camera correctly, the wrong posture can cause the camera to shake. Stand up straight and remain still to maintain a steady base for your camera. When shooting with a slow shutter speed, hold your breath to minimize body movement.

### Holding the camera

Hold the camera with your right hand and place your right index finger on the shutter button. Place your left hand under the lens for support.

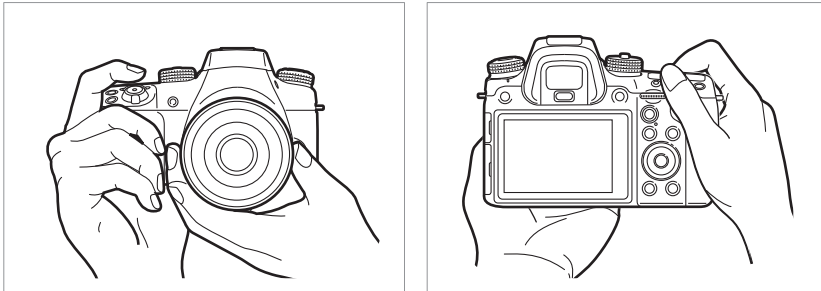

### Standing photography

Compose your shot, stand up straight with your feet shoulder-length apart, and keep your elbows pointed down.



## Crouching photography

Compose your shot, crouch with one knee touching the ground, and keep a straight posture.



## Using the display

To take photos at high or low angles, tilt the display up or down. You can tilt the display up to 90° upwards (B) or 45° downwards (C).

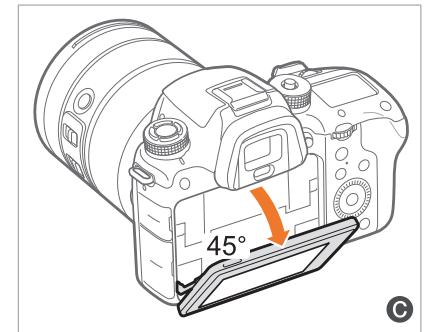
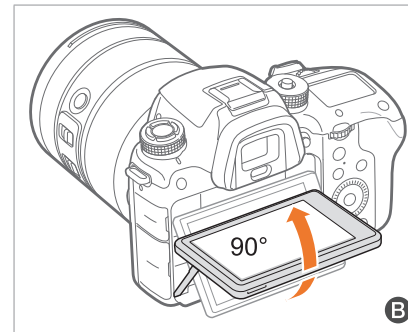
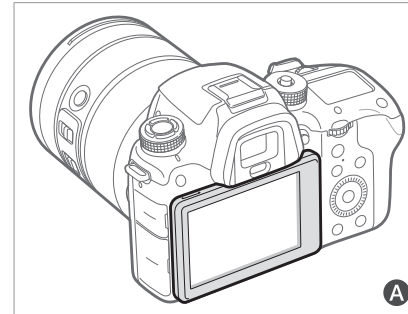

- Keep the display closed (A) when the camera is not in use.
- Tilt the display only within the angle allowed. Failing to do so may damage your camera.



### Low-angle shot

A low-angle shot is a shot from a camera positioned below your eyeline, looking up the subject.

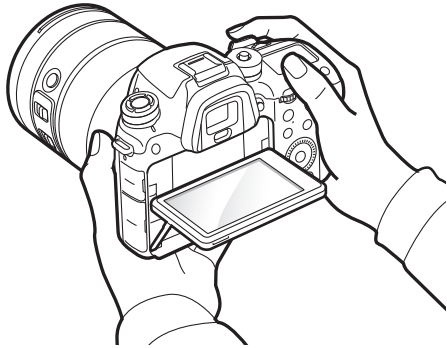

### High-angle shot

A high-angle shot is a shot from a camera positioned above your eyeline, looking down on the subject.

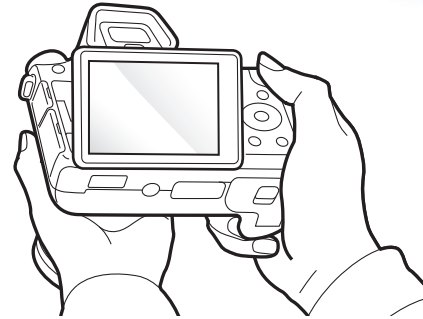

## Aperture

The aperture is one of the three factors that determine the exposure. The aperture housing contains thin, metal plates that open and close to let light through the aperture and into the camera. The size of the aperture is related to the amount of light: a larger aperture allows more light and a smaller aperture allows less light.

### Aperture sizes

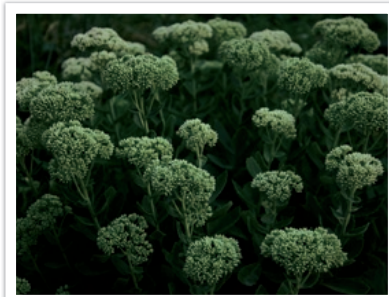
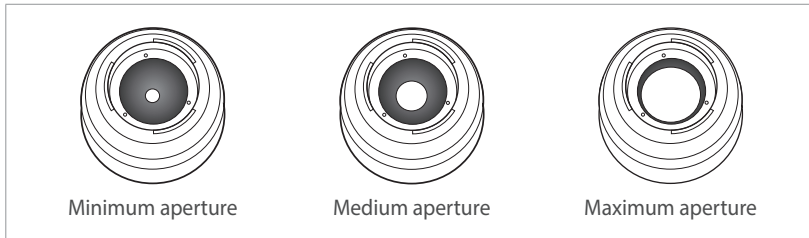

Aperture opened slightly



Aperture opened wide

The size of the aperture is represented by a value known as an “F-number”. The f-number represents the focal length divided by the diameter of the lens. For example, if a lens with a 50 mm focal length has an f-number of F2, the diameter of the aperture is 25 mm. ( $50 \text{ mm} / 25 \text{ mm} = F2$ ) The smaller the f-number, the greater the size of the aperture.

The size of the aperture opening is defined as the Exposure Value (EV). Increasing the Exposure Value (+1 EV) means the amount of light doubles. Decreasing the Exposure Value (-1 EV) means the amount of light halves. You can also use the exposure compensation feature to fine-tune the amount of light by subdividing exposure values into 1/2, 1/3 EV, and so on.

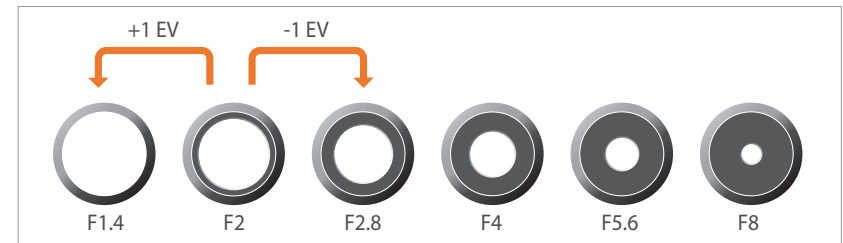

Exposure Value Steps

## Aperture value and the depth of field

You can blur or sharpen the background of a photo by changing the size of the aperture. A large aperture gives your photos a shallow depth of field (DOF). Objects immediately in front of or behind your subject will be blurred, while the subject will be in focus. A small aperture gives your photos a deep depth of field. Objects far in front or far behind your subject and your subject will be in focus.



A photo with a deep DOF



A photo with a shallow DOF



The aperture housing contains several blades. These blades move together and control the amount of light passing through the center of the aperture. The number of blades also affects the shape of light when shooting night scenes. If an aperture has an even number of blades, light divides into an equal number of sections. If the number of blades is odd, the number of sections is double the number of blades.

For example, an aperture with 8 blades divides light into 8 sections and an aperture with 7 blades into 14 sections.

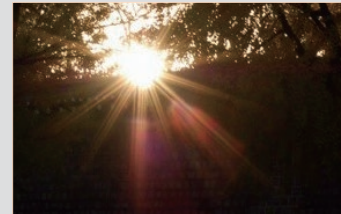

7 blades

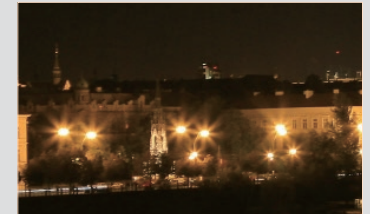

8 blades

## Shutter speed

Shutter speed refers to the amount of time it takes to open and close the shutter. It controls the amount of light which passes through the aperture before it reaches the image sensor.

Shutter speeds are measured in seconds and parts of a second. On many cameras, the shutter speeds are approximately halved with each succeeding setting - 1 s, 1/2 s, 1/4 s, 1/8 s, 1/15 s, etc. Like successive aperture settings, each successive shutter speed setting lets in about half the amount of light. Consequently, each successive shutter speed setting equals an EV (Exposure Value) change of about 1 EV.

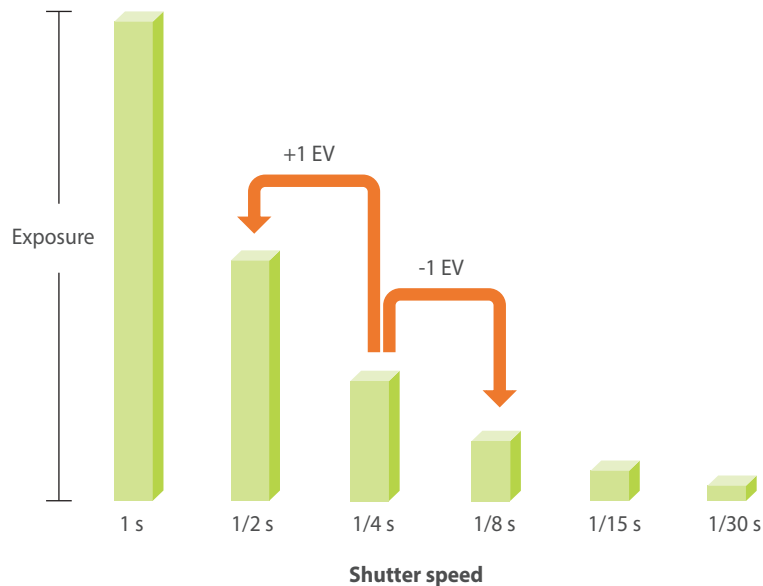

Therefore, the faster the shutter speed, the less light will be let in. Likewise, the slower the shutter speed, the more light will be let in.

A slow shutter speed allows more light into the camera to make photos brighter. However, because the shutter is open longer, moving subjects appear blurred. A fast shutter speed allows less light in to make photos darker. However, because the shutter is open for a shorter time, moving subjects look sharper and more focused.

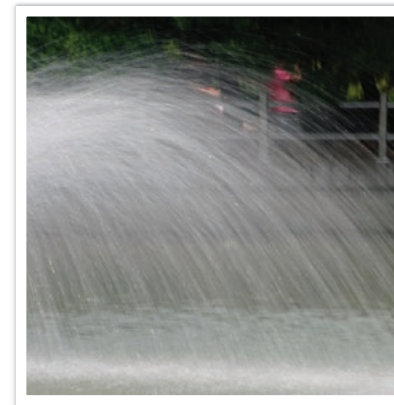

1 s

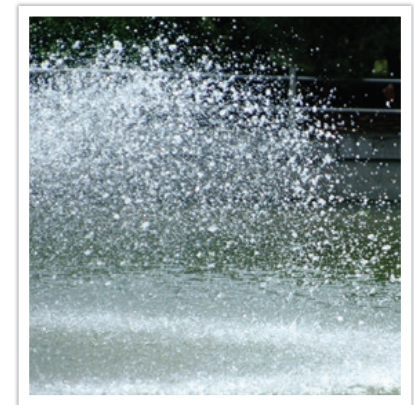

1/250 s

## ISO sensitivity

The exposure of an image is determined by the sensitivity of the camera. This sensitivity is based on international film standards, known as ISO standards. On digital cameras, this sensitivity rating is used to represent the sensitivity of the digital mechanism that captures the image.

ISO sensitivity doubles as the number doubles. For example, an ISO 200 setting is capable of capturing images at twice the speed of an ISO 100 setting. However, higher ISO settings can result in “noise”—small specks, spots, and other phenomena in a photo that give the shot a noisy or dirty appearance. As a general rule, it is best to use a low ISO setting to prevent noise in your photos, unless you are shooting in darkened environments or at night.



Changes in the quality and brightness according to ISO sensitivity

Because a low ISO sensitivity means the camera will be less sensitive to light, you need more light to have an optimal exposure. When using a low ISO sensitivity, open the aperture more or reduce the shutter speed to allow more light to enter the camera. For example, on a sunny day when light is abundant, a low ISO sensitivity does not require a slow shutter speed. However, in a dark place or at night, a low ISO sensitivity will result in a blurry photo. Therefore, it is recommended to increase the ISO sensitivity by a moderate amount.



A photo captured with a tripod and high ISO sensitivity





A blurred photo with a low ISO sensitivity

## How the aperture setting, shutter speed, and ISO sensitivity control exposure

The aperture setting, shutter speed, and ISO sensitivity are closely interconnected in photography. The aperture setting controls the opening that regulates the light that enters the camera, while the shutter speed determines the length of time that light is allowed to enter. ISO sensitivity determines the speed at which the film reacts to light. Together, these three aspects are described as the triangle of exposure.

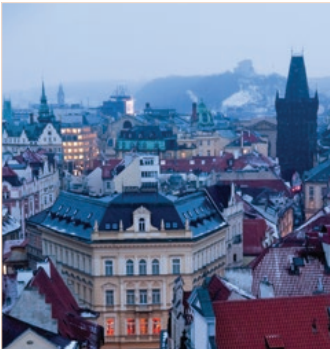
A change in shutter speed, aperture value, or ISO sensitivity can be offset by adjustments to the others to maintain the amount of light. The results, however, change according to the settings. For example, shutter speed is useful in expressing movement, aperture can control the depth of field, and ISO sensitivity can control the graininess of a photo.

	Settings	Results
<b>Aperture value</b>	Wide aperture = more light Narrow aperture = less light	 Wide = shallow depth of field Narrow = deep depth of field

	Settings	Results
<b>Shutter speed</b>	Fast speed = less light Slow speed = more light	 Fast = still Slow = blurry
<b>ISO sensitivity</b>	High sensitivity = more sensitive to light Low sensitivity = less sensitive to light	 High = more grainy Low = less grainy

## Correlation between focal length, angle, and perspective

Focal length, which is measured in millimeters, is the distance between the middle of the lens to its focal point. It affects the angle and perspective of captured images. A short focal length translates into a wide angle, which allows you to capture a wide shot. A long focal length translates into a narrow angle, which allows you to capture telephoto shots.

### Short focal length

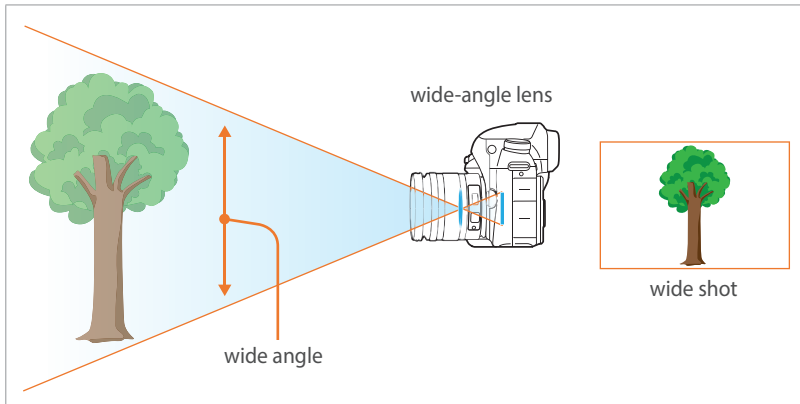

### Long focal length

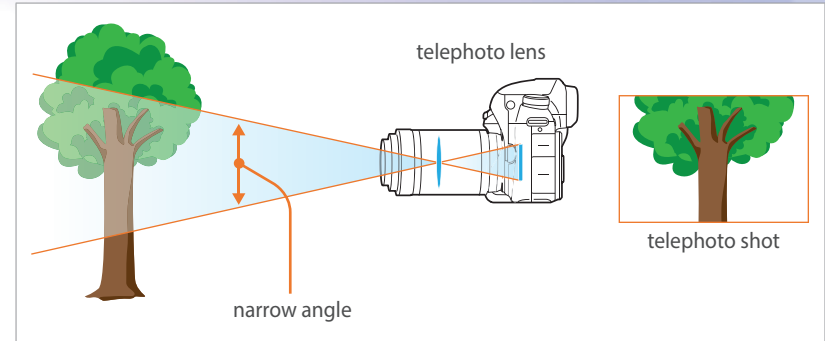

Look at these photos below and compare the changes.



16 mm angle



50 mm angle



200 mm angle



Normally, a lens with a wide angle is suitable for shooting landscapes and a lens with a narrow angle is recommended for shooting sports events or portraits.

## Depth of field

The depth of field (DOF) is the focused area around the subject.

In general, the DOF can be shallow or deep. In photos with a shallow DOF, the subject is sharply focused, the background is blurred and the subject stands out. In contrast, photos with a deep DOF have all the elements of the photo in sharp focus.

You can create a photo with a shallow DOF by using a telephoto lens or by selecting a low aperture value. You can create a photo with a deep DOF by using a wide angle lens or by selecting a high aperture value.



Shallow Depth of Field

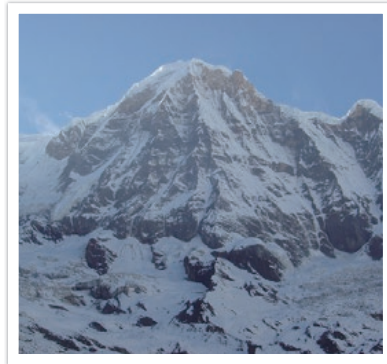

Deep Depth of Field

### What controls out-of-focus effects?

#### DOF depends on the aperture value

A low aperture value indicates that the aperture has a wide opening. The wider the aperture, the shallower the DOF becomes. Conversely, a high aperture value indicates that the aperture has a narrow opening. The narrower the aperture, the deeper the DOF becomes.



50 mm F5.7



50 mm F22



## DOF depends on focal length

The longer the focal length, the shallower the DOF. A telescopic lens with a longer focal length will capture a photo with a shallow DOF better than a lens with a shorter focal length.



A photo captured with an 16 mm wide-angle lens

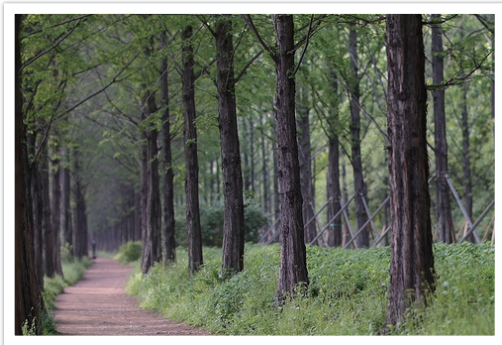

A photo captured with a 100 mm telescope lens

## DOF depends on the distance between the subject and the camera

The shorter the distance between the subject and the camera, the shallower the DOF is. Therefore, taking a photo close to a subject generally results in a photo with a shallow DOF.

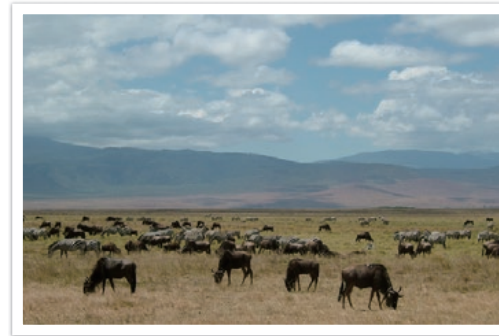

A photo captured with a 100 mm telescope lens

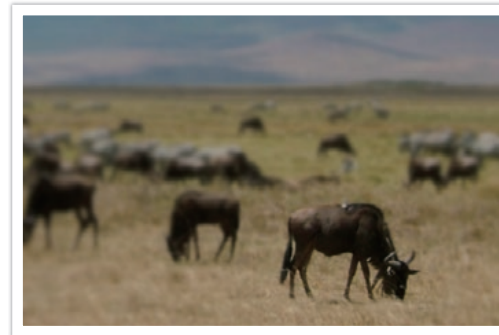

A photo captured close to the subject

## DOF preview

You can press the Preview button to get an idea of what your shot will look like before shooting. The camera adjusts the aperture to the predefined settings and shows the results on the screen. Set the function of the Preview button to **Optical Preview**. (p. 189)

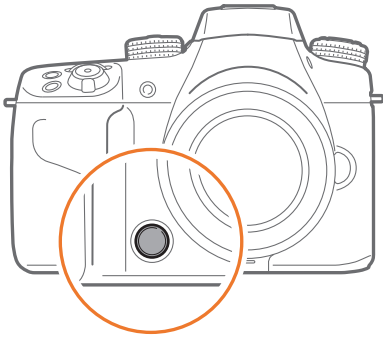

## Composition

The way that objects are arranged in a photo is referred to as its composition. A good composition emphasizes the photo's subjects by drawing attention to them and by balancing them with the other elements in the photo.

Following the rule of thirds is one method that usually results in good compositions.

### Rule of Thirds

To use the rule of thirds, divide the image into a 3x3 pattern of equal rectangles.

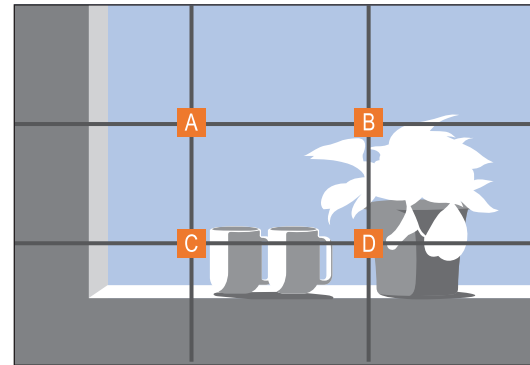

To compose photos that best emphasize the subject, make sure the subject is located at one of the corners of the center rectangle.

Using the rule of thirds will create photos with stable and compelling compositions. Below are a few examples.

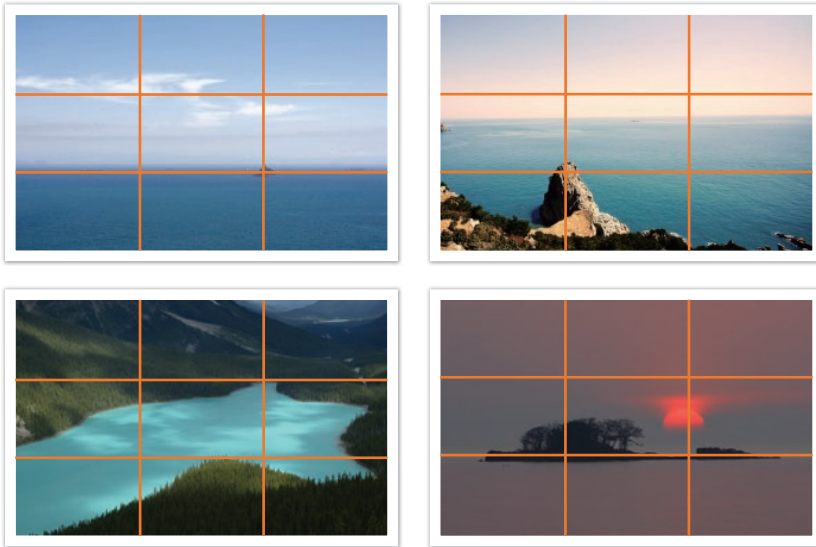

### Photos with two subjects

If your subject is in one corner of the photo, it creates an unbalanced composition. You can stabilize the photo by capturing a second subject in the opposite corner to balance the weight of the photo.

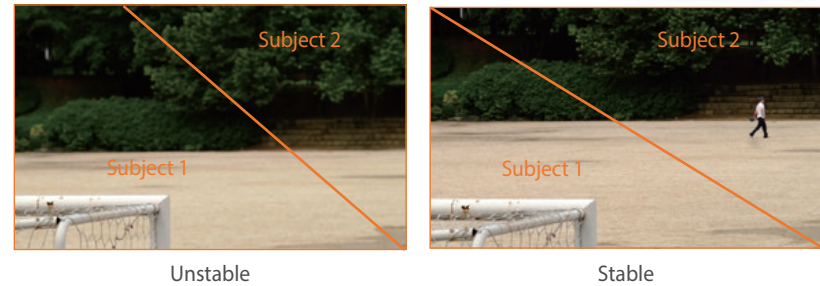

When taking landscape photos, centering the horizon will create an unbalanced effect. Give more weight to the photo by moving the horizon up or down.



## Flash

Light is one of the most important components in photography. However, you will not always have enough of light in all situations. Making use of a flash allows you to compensate for the lack of light and create a variety of effects.

The flash, also known as a strobe or speed light, provides adequate exposure in low-light conditions. It is also useful in light-abundant situations. For example, you can use the flash to provide light when a subject is in shadow or use it to capture clearly both the subject and the background under backlit conditions.



Back lit subjects without flash



Back lit subjects with flash

### Flash guide number

The model number of a flash refers to the flash's power, and the maximum amount of light created is represented by a value known as the "guide number". A flash with a higher guide number emits a larger amount of light than a flash with a lower guide number. The guide number is calculated by multiplying the distance from the flash to the subject by the aperture value when the ISO sensitivity is set to 100.

**Guide number = Flash to Subject Distance X Aperture value**

**Aperture value = Guide number/Flash to Subject Distance**

**Flash to Subject Distance = Guide number/Aperture value**

If you know the flash's guide number, you can estimate an appropriate flash-to-subject distance when setting the flash manually. For example, if a flash has a guide number of GN 20 and is 4 meters away from the subject, the optimal aperture value is F5.0.

## Bounce Photography

Bounce photography refers to the method of bouncing light off of the ceiling or walls so that the light spreads evenly over the subject. Normally, photos captured with the flash may appear unnatural and cast shadows. Subjects in photos captured with bounce photography cast no shadows and look smooth due to evenly spread light.





# Chapter 1

# My Camera

---

Learn about your camera's layout, display icons, lens, optional accessories, and basic functions.

# Getting started

## Unpacking

Check your product box for the following items.

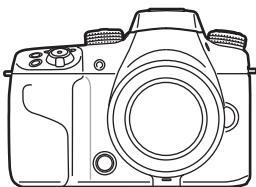

Camera  
(including the body cap, hot-shoe cover, and vertical grip connector cover)

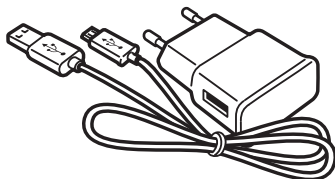

AC adapter/USB cable

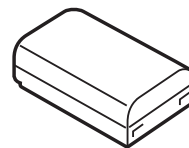

Rechargeable battery

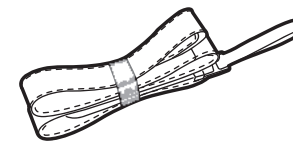

Strap

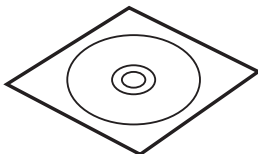

Adobe Photoshop Lightroom DVD-ROM

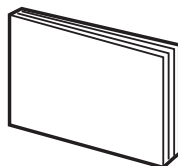

Quick Start Guide



- The illustrations may differ from your actual items.
- You can purchase optional accessories at a retailer or a Samsung service center. Samsung is not responsible for any problems caused by using unauthorized accessories. For information about accessories, refer to page 232.

# Camera layout

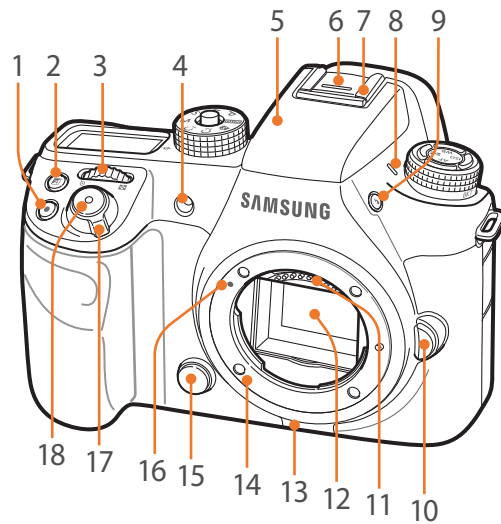

No.	Name
1	Video recording button
2	<b>EV button</b> Press and hold the button, and then scroll command dial 2 to adjust the exposure value. (p. 126)
3	<b>Command dial 1</b> <ul style="list-style-type: none"> <li><b>In the Menu screen:</b> Move to a desired menu item.</li> <li><b>In the Smart panel:</b> Adjust a selected option.</li> <li><b>In Shooting mode:</b> Adjust shutter speed, aperture value, Program Shift settings, exposure value, or ISO sensitivity in some shooting modes or change the size of a focus area. (p. 187)</li> <li><b>In Playback mode:</b> View thumbnails or enlarge or reduce a photo. Open or close a photo bundle in Playback mode. Scan backward or forward a video.</li> </ul>
4	AF-assist light/Timer lamp
5	Built-in flash (p. 117)
6	Hot-shoe cover

No.	Name
7	Hot-shoe
8	Microphone
9	Flash pop-up button (p. 117)
10	Lens release button
11	<b>Lens contacts</b> * Avoid contact with or prevent damage to the lens contacts.
12	<b>Image sensor</b> * Avoid contact with or prevent damage to the image sensor.
13	Speaker
14	Lens mount
15	Preview button (p. 25)
16	Lens mount index
17	Power switch
18	Shutter button



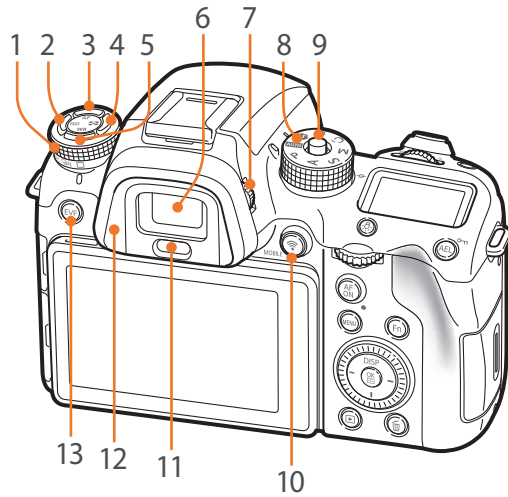

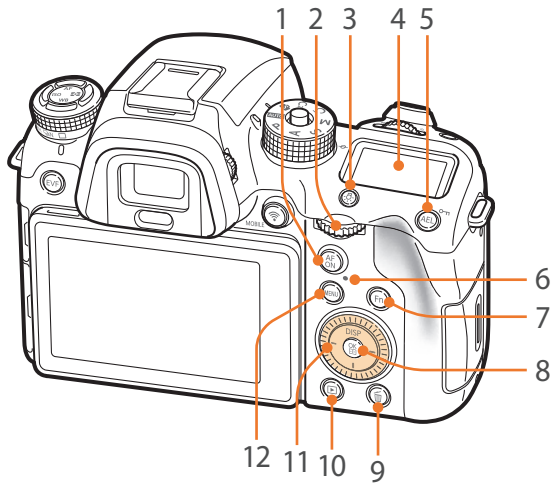

No.	Name
1	Drive dial (p. 110)
2	ISO button
3	AF mode button
4	Metering button
5	WB button
6	Viewfinder
7	<b>Diopter adjustment dial</b> If the image is not clear through the viewfinder, rotate the diopter adjustment dial to improve the image.
8	<b>Mode dial</b> <ul style="list-style-type: none"> <li>• <b>AUTO</b>: Auto mode (p. 70)</li> <li>• <b>P</b>: Program mode (p. 72)</li> <li>• <b>A</b>: Aperture Priority mode (p. 74)</li> <li>• <b>S</b>: Shutter Priority mode (p. 75)</li> <li>• <b>M</b>: Manual mode (p. 76)</li> <li>• <b>C1</b>: Custom1 mode (p. 77)</li> <li>• <b>C2</b>: Custom2 mode (p. 77)</li> <li>• <b>S</b>: Smart mode (p. 79)</li> </ul>

No.	Name
9	<b>Mode dial lock button</b> Press the lock button to lock the mode dial to prevent it from rotating unintentionally.
10	<b>MOBILE button</b> Select a Wi-Fi function.
11	<b>Proximity sensor</b>
12	<b>Eye-cup</b>
13	<b>EVF button</b> Set to use the viewfinder or main display. (p. 36)



No.	Name
1	<b>AF start button</b> <ul style="list-style-type: none"> <li>• <b>When capturing a photo:</b> Press and hold this button to measure the brightness of the focus area, set the optimum exposure value, and lock the focus.</li> <li>• <b>When recording a video:</b> Switch between AF and MF.</li> </ul>
2	<b>Command dial 2</b> <ul style="list-style-type: none"> <li>• <b>In the Menu screen:</b> Move to a desired menu item.</li> <li>• <b>In the Smart panel:</b> Move to a desired option.</li> </ul>

No.	Name
2	<ul style="list-style-type: none"> <li>• <b>In Shooting mode:</b> Adjust shutter speed, aperture value, Program Shift settings, exposure value, or ISO sensitivity in some shooting modes or move the focus area. (p. 187)</li> <li>• <b>In Playback mode:</b> View previous or next file. Scan backward or forward in a video.</li> </ul>
3	<b>Status display window illumination button</b> Illuminate the status display window.
4	<b>Status display window</b> View the current AF mode, metering option, battery life, White Balance option, or ISO sensitivity. (p. 56)
5	<b>AEL button (p. 128)</b> <ul style="list-style-type: none"> <li>• <b>In Shooting mode:</b> Lock the adjusted exposure value or focus.</li> <li>• <b>In Playback mode:</b> Protect the selected file.</li> </ul>
6	<b>Status lamp</b> Indicate the status of the camera. <ul style="list-style-type: none"> <li>• <b>Blinking:</b> When saving a photo, shooting a video, sending data to a computer, connecting to WLAN, or sending a photo.</li> <li>• <b>Steady:</b> When there is no data transfer, when data transfer to a computer is complete, or charging the battery.</li> </ul>

No.	Name
7	<b>Fn button</b> <ul style="list-style-type: none"> <li>• <b>When capturing a photo:</b> Access the Smart panel to fine-tune settings.</li> <li>• <b>When recording a video:</b> Switch between Single AF and Continuous AF.</li> </ul>
8	 <b>button</b> <ul style="list-style-type: none"> <li>• <b>In the Menu screen:</b> Save the selected options.</li> <li>• <b>In Shooting mode:</b> Allows you to select a focus area manually in some shooting modes.</li> </ul>
9	<b>Delete button</b> <ul style="list-style-type: none"> <li>• <b>In Playback mode:</b> Delete files.</li> <li>• <b>In Shooting mode:</b> Set the shooting speed when Continuous High is selected, set the timer details when Timer is selected, or select a bracketing method when using Bracket. (p. 189)</li> </ul>
10	<b>Playback button</b> Enter Playback mode to view pictures or videos.
11	<b>Navigation button (Custom wheel)</b> <ul style="list-style-type: none"> <li>• <b>In Shooting mode</b> <ul style="list-style-type: none"> <li>- DISP: Change the information on the display.</li> <li>-  / : Perform the assigned function. (p. 189)</li> </ul> </li> <li>• <b>In other situations</b>                      Move up, down, left, right, respectively. (You can also rotate the wheel.)</li> </ul>
12	<b>MENU button</b> Access options or menus.

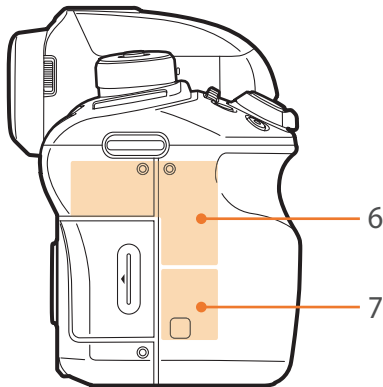
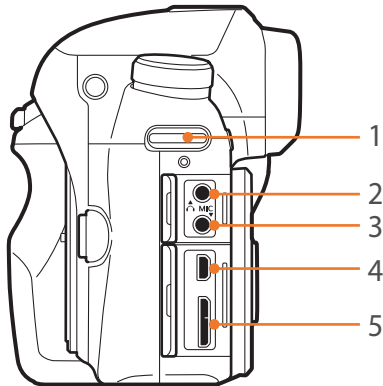

No.	Name
1	<b>Eyelet for camera strap</b>
2	<b>Headset port</b> Insert a 3.5 mm stereo headset plug.
3	<b>External microphone port</b> Insert a 3.5 mm stereo microphone plug.
4	<b>HDMI port</b>
5	<b>USB and shutter release port</b> Connect the camera to a computer or shutter release. Use a shutter release cable with a tripod to minimize camera movement.
6	<b>Internal antenna</b> * Avoid contact with the internal antenna while using a wireless network.
7	<b>NFC tag</b>

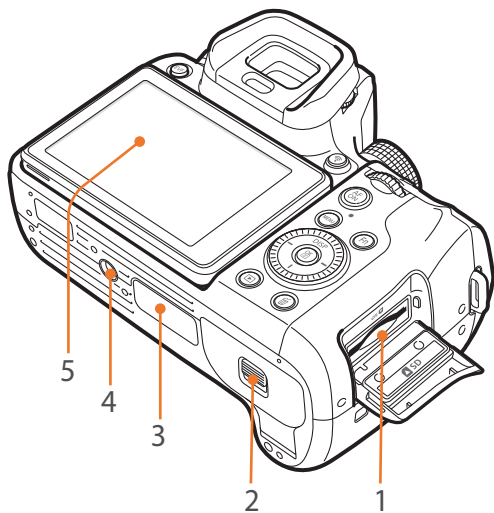

No.	Name
1	<b>Memory card slot</b> Insert a memory card.
2	<b>Battery chamber cover</b> Insert a battery.
3	<b>Vertical grip connector (cover)</b> Connect the vertical grip (optional) to capture portraits conveniently and extend battery life. * When connecting to a vertical grip, remove the vertical grip connector cover and store it in the slot on the vertical grip.
4	<b>Tripod mount</b>
5	<b>Touch screen (main display)</b> <ul style="list-style-type: none"> <li>• To take photos at high or low angles, tilt the display up or down. (p. 15)</li> <li>• Touch the screen to select a menu or an option. (p. 44)</li> </ul>

## Using the EVF button

Press [EVF] repeatedly to set how the main display and viewfinder function.

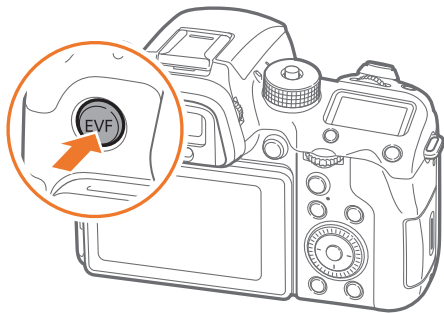

\* Default

Option	Description
<b>EVF : Auto*</b>	Set the proximity sensor to automatically select the main display or viewfinder.

\* Default

Option	Description
<b>EVF</b>	<p>Set to use the viewfinder.</p> <div style="border: 1px solid gray; padding: 10px; background-color: #f0f0f0;">  <ul style="list-style-type: none"> <li>• While you are using the viewfinder, Quick View is not available.</li> <li>• When you remove your eye from the viewfinder within 5 seconds after shooting, the camera displays an image preview on the main display for the length of time you set. The camera automatically returns to viewfinder mode when the preview is closed.</li> <li>• The camera automatically selects the main display or the viewfinder using the proximity sensor in the following situations:                             <ul style="list-style-type: none"> <li>- When you use menus, the smart panel, or preview photos.</li> <li>- When you adjust shooting options by pressing [ISO], [AF], or [WB].</li> </ul> </li> </ul> </div>
<b>EVF : Off</b>	Set to use the main display.



- Wi-Fi functions, slideshow functions, interval shots playback, and **Manage Custom Mode - Edit Image** functions are not available when you use the viewfinder.
- The camera does not automatically select the main display or viewfinder when you record or play videos. For example, if you start recording or playing a video while looking through the viewfinder, the main display will not be available during recording or playback.

# Inserting the battery and memory card

Learn how to insert the battery and an optional memory card into the camera.

## Inserting the battery

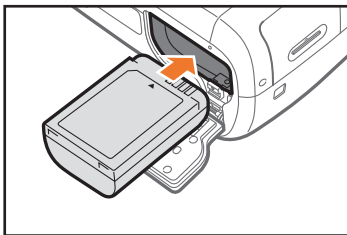
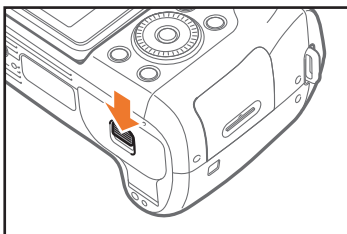

Insert the battery with the gold-colored contacts facing up.

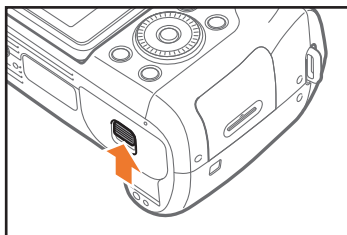
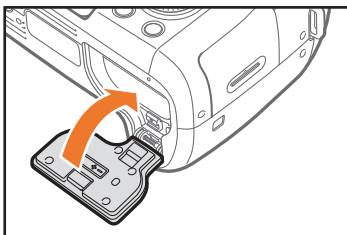

## Inserting a memory card

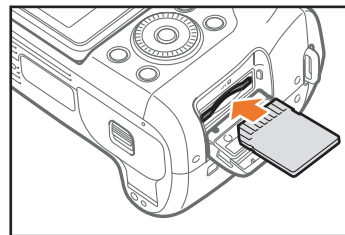
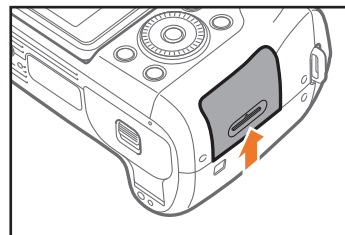

Insert a memory card with the gold-colored contacts facing up.

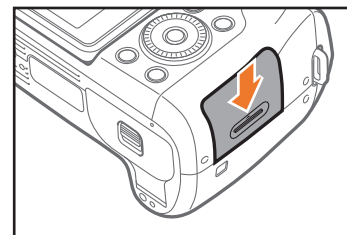
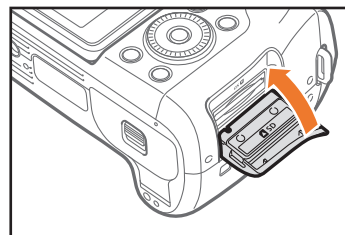

## Removing the battery and memory card

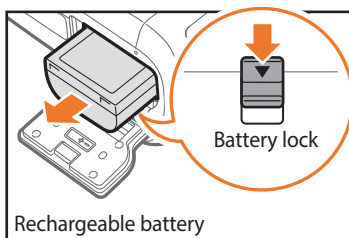

Slide the lock down to release the battery.

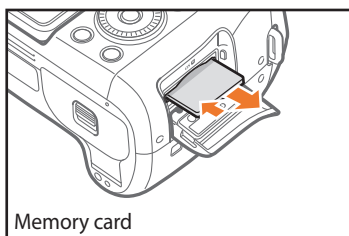

Push the card gently until it disengages from the camera, and then pull it out of the slot.

## Using the memory card adapter

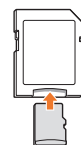

To use micro memory cards with this product, a PC, or a memory card reader, insert the card into an adapter.



While the status lamp of the camera is blinking, do not remove the memory card or battery. Doing so may damage the data stored on the memory card or your camera.

# Charging the battery and turning on your camera

## Charging the battery

Before you use the camera for the first time, you must charge the battery. Plug the small end of the USB cable into your camera, and then plug the other end of the USB cable into the AC adapter.

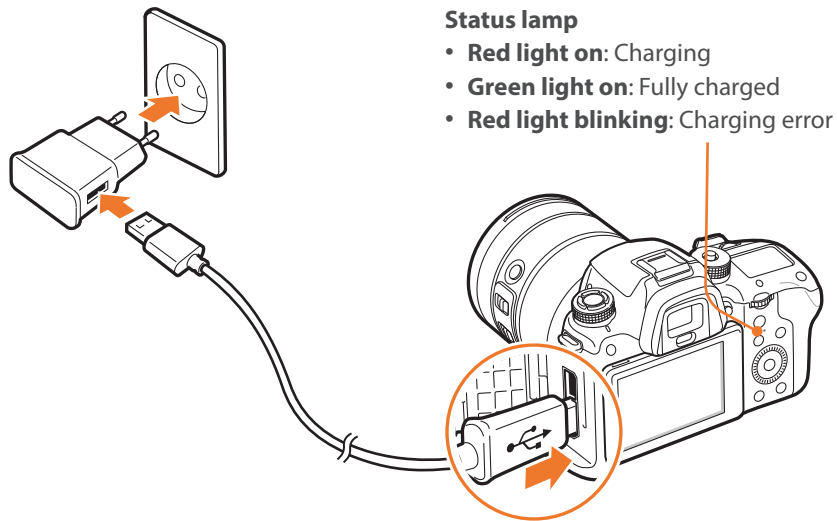

When using a USB 2.0 cable, plug the USB cable into the lower side of the USB port. If the plug connectors are forced, the device may be damaged. The manufacturer is not responsible for any loss of data.



- Charge the battery while the camera is turned off.
- Use only the AC adapter and USB cable supplied with your camera. If you use another AC adapter, the camera battery may not charge or work properly.
- When using a USB 3.0 cable (optional), connect the USB cable as shown in the illustration.

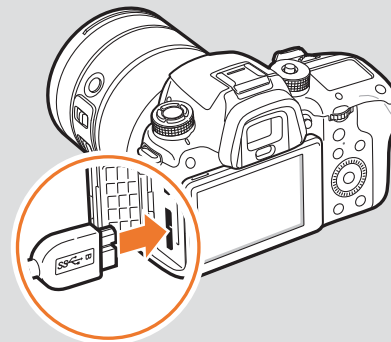



## Turning on your camera

Set the Power switch to **ON**.

- To turn your camera off, set the Power switch to **OFF**.
- The initial setup screen appears when you turn on the camera for the first time. (p. 41)

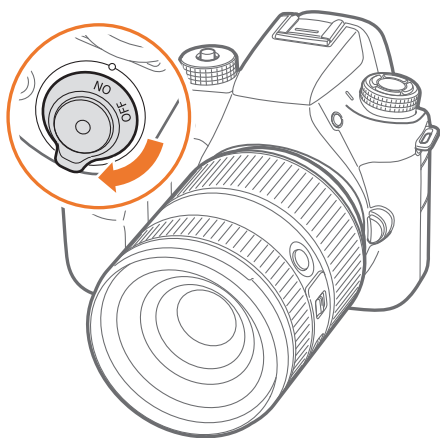

# Performing the initial setup

When you turn on your camera for the first time, the initial setup screen appears. The language is preset for the country or region where the camera is sold. You can change the language as desired. You can also select an item by touching it on the screen.

- 1 Press [I] to select **Time Zone**, and then press [OK].
- 2 Press [DISP/I] to select a time zone, and then press [OK].

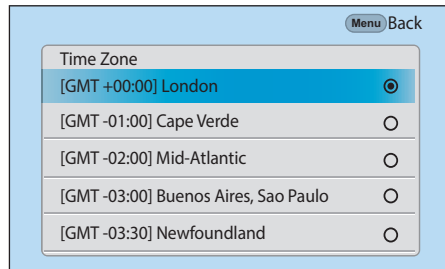

- 3 Press [I] to select **Date Settings**, and then press [OK].
- 4 Press [-/-] to select an item (Year/Month/Day).

- 5 Press [DISP/I] to set the option, and then press [OK].

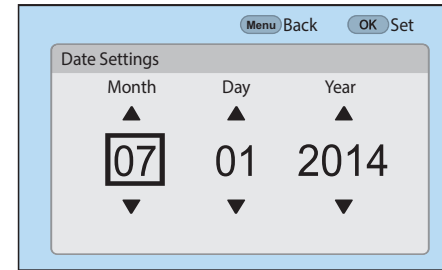

- The screen may differ depending on the language you selected.

- 6 Press [I] to select **Time Settings**, and then press [OK].
- 7 Press [-/-] to select an item (Hour/Minute/Summer time).
- 8 Press [DISP/I] to set the option, and then press [OK].

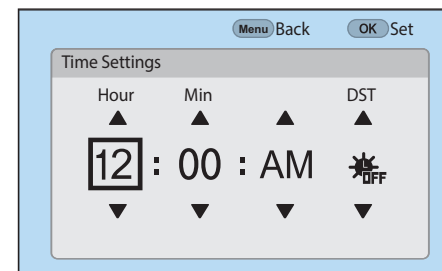

9 Press [I] to select **Date Type**, and then press [OK].

10 Press [DISP/I] to select a date type, and then press [OK].

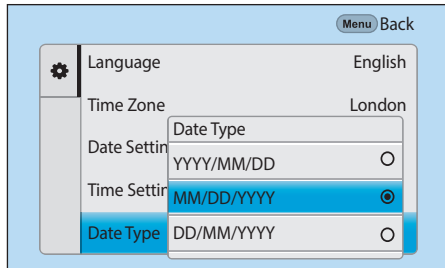

11 Press [I] to select **Time Type**, and then press [OK].

12 Press [DISP/I] to select a time type, and then press [OK].

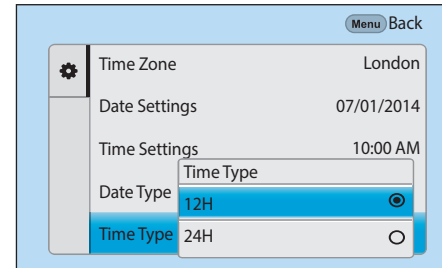

13 Press [MENU] to finish the initial setup.

# Selecting functions (options)

## Using buttons and dials

Use one of the following methods to select an option:

- Scroll command dial 1, and then press [OK].
- Scroll command dial 2, and then press [OK].
- Rotate the navigation button, and then press [OK].
- Press [DISP/II/—/—], and then press [OK].

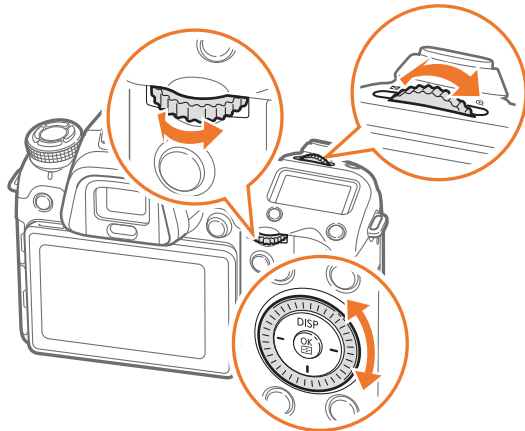

## Using custom buttons and dials

Assign various buttons and dials to launch your favorite functions. Functions can be assigned to the following buttons and dials: preview button, AEL button, AF start button, navigation button (custom wheel), delete button, command dials 1 and 2, video recording button, and MOBILE button.

For example, to assign Flash, ISO, and Metering to the navigation button, follow the steps below.

- 1 In Shooting mode, [MENU] →  → **Key Mapping**.
- 2 Select a button from the list.

### 3 Select a function.

- You can change the assigned functions of each button to a desired function.

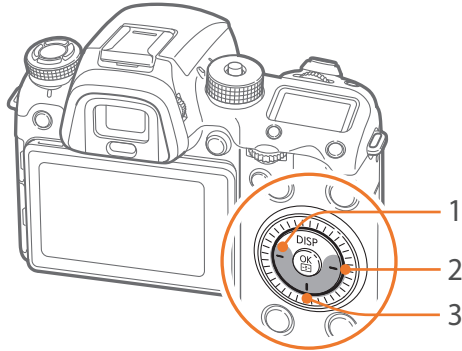

No.	Default	Assigned
1	AF Area	Flash
2	Movie STBY	ISO
3	Picture Wizard	Metering

### 4 Press [MENU] to move to the previous screen.

### 5 Set shooting options by using the custom buttons, and then capture a photo.

## Selecting by touch



Do not use sharp objects, such as pens or pencils, to touch the screen. You can damage the screen.

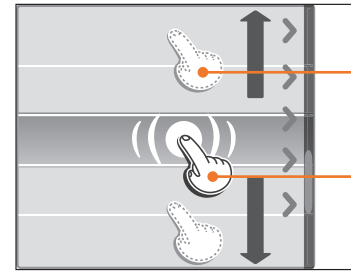

**Dragging:** Touch and hold an area on the screen, and then drag your finger.

**Touching:** Touch an icon to select a menu or an option.

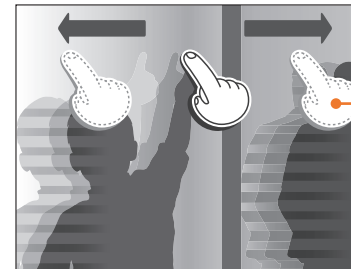

**Flicking:** Gently flick your finger across the screen.



- When you touch or drag the screen, discolorations may occur. This is not a malfunction, but a characteristic of the touch screen. Touch or drag lightly to minimize the discolorations.
- The touch screen may not work properly if you use the camera in extremely humid environments.
- The touch screen may not work properly if you apply screen protection film or other accessories to the screen.
- Depending on the viewing angle, the screen may appear dim. Adjust the brightness or viewing angle to improve the resolution.

## Using MENU

Press [MENU] or touch **MENU** on the screen, and then change shooting options or settings.

### E.g. Selecting the photo size in P mode

- 1 Rotate the mode dial to P.
- 2 Press [MENU] or touch **MENU**.

3 Scroll command dial 1 or press [DISP/II] to move to , and then press **[OK]**.

- You can also touch  on the screen.

4 Rotate the navigation button or press [DISP/II] to move to **Photo Size**, and then press **[OK]**.

- You can also drag the option list, and then touch an option.



5 Rotate the navigation button or press [DISP/I] to move to an option, and then press [OK].

- You can also drag the option list, and then touch an option.
- Press [MENU] or touch **Back** to go back to the previous menu.

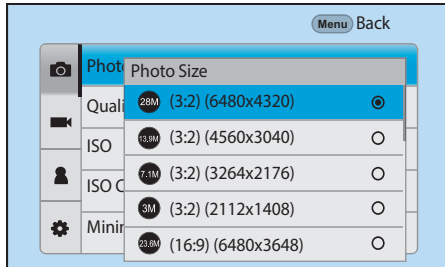

6 Press [MENU] or touch **Back** to switch to Shooting mode.



You can press [MENU] or touch **MENU** on the screen to change shooting options even in Video recording standby mode.

## Using the smart panel

Press [Fn] or touch **Fn** on the screen to access some functions such as Exposure, ISO, and White Balance.

E.g. Adjust the exposure value in P mode

- 1 Rotate the mode dial to P.
- 2 Press [Fn] or touch **Fn**.

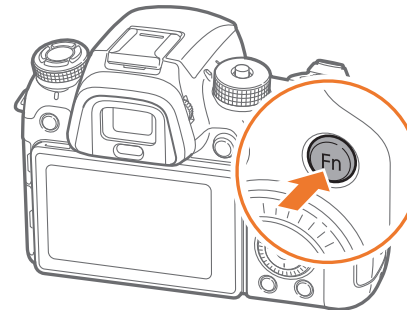

3 Scroll command dial 2 or rotate the navigation button or press [DISP/|/—/—] to move to **EV**, and then press [].

- You can directly select an option by scrolling command dial 1 without having to press [].
- You can also select an option by touching it.

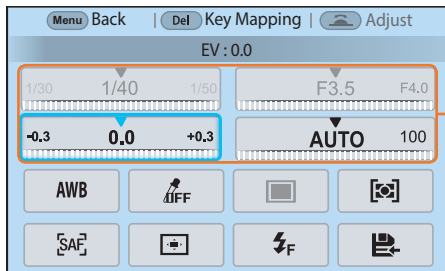

You can adjust some options by dragging them.

4 Scroll command dial 1 or command dial 2, or rotate the navigation button, or press [—/—] to adjust the exposure value, and then press [].

- You can also drag the dial on the screen, and then touch **Set** to adjust the option.

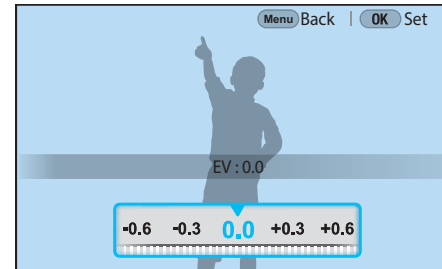



## Using iFn

Press [**i-Function**] on an i-Function lens to manually select and adjust shutter speed, aperture value, exposure value, ISO sensitivity, and White Balance on the lens.

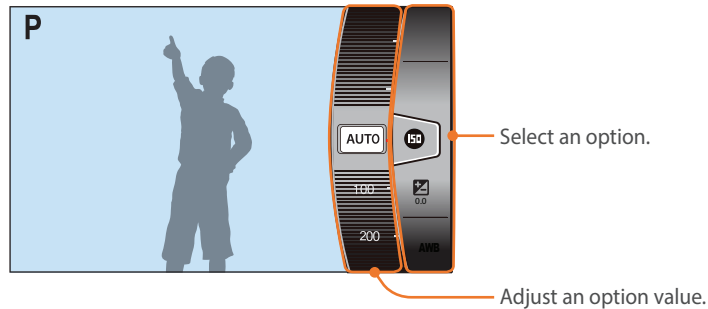

1 Rotate the mode dial to P, A, S, or M.

2 Press [**i-Function**] on the lens to select a setting.

- To select items to appear, select [MENU] → ⌘ → **iFn Customizing** → an item.

- You can also press [**i-Function**], and then press [DISP/II] or drag the screen to select a setting.

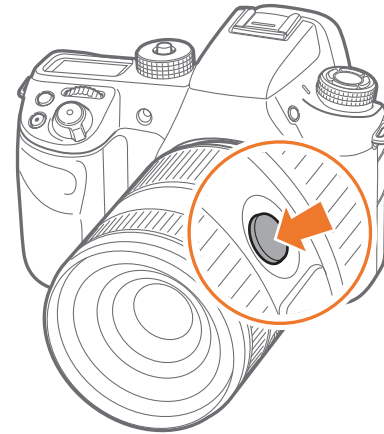

Option	Description
<b>Aperture</b>	Adjust the aperture value.
<b>Shutter Speed</b>	Adjust the shutter speed.
<b>EV</b>	Adjust the exposure value.
<b>ISO</b>	Adjust the ISO sensitivity.
<b>White Balance</b>	Select a White Balance option.
<b>intelli-Zoom</b>	Zoom in on a subject with less degradation of photo quality than the Digital zoom. However, the photo resolution or size may change compared to when you zoom in by rotating the zoom ring.

### 3 Adjust the focus ring to select an option.

- You can also scroll command dial 2 or rotate the navigation button or drag the screen to select an option.

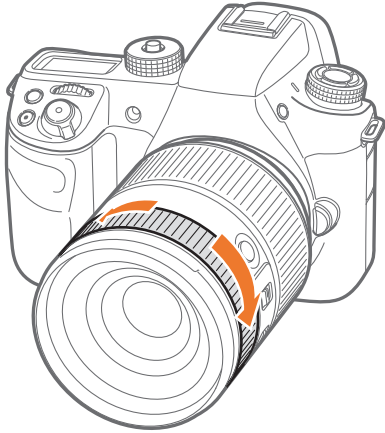

### 4 Half-press [Shutter] to focus, and then press [Shutter] to capture the photo.

### Available options

Shooting mode	P	A	S	M	3D
Aperture	-	O	-	O	-
Shutter Speed	-	-	O	O	-
EV	O	O	O	-	O
ISO	O	O	O	O	-
White Balance	O	O	O	O	O
intelli-Zoom	O	O	O	O	-



- This function is not available when you attach a 3D lens and set **3D Auto Mode** in 3D mode.
- intelli-Zoom is not available when you capture photos in the RAW file format.
- intelli-Zoom is deactivated when you continuously capture photos.
- intelli-Zoom is deactivated when you record videos by pressing the video recording button.

# Display icons

## In Shooting mode

### Capturing photos

#### 1. Shooting information

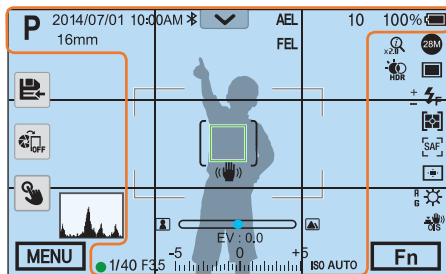

Icon	Description
<b>P</b>	Shooting mode
2014/07/01	Current date
10:00AM	Current time
	Bluetooth on
16mm	Focal length*
	Notification panel bar (Touch)
	Memory card not inserted**
<b>AEL</b>	Auto exposure lock (p. 128)
<b>AFL</b>	Auto focus lock (p. 128)
<b>FEL</b>	Flash intensity lock (p. 121)
<b>10</b>	Available number of photos
100%	Battery percentage
	Auto focus frame
[ ]	Spot metering area
	<ul style="list-style-type: none"> <li>: Fully charged</li> <li>: Partially charged</li> <li> (Red): Empty (recharge the battery)</li> <li>: Charging</li> <li>: Internal battery in use (when the vertical grip is connected)</li> <li>: External battery in use (when the vertical grip is connected)</li> </ul>

Icon	Description
	Camera shake
	Manual focus scale
	Level gauge (p. 53)
	Histogram (p. 127)
	Focus
1/40	Shutter speed
F3.5	Aperture value
EV : 0.0	Exposure adjustment value
	Exposure level display
<b>ISO AUTO</b>	ISO sensitivity (p. 91)

\* This icon appears when you attach the Power Zoom lens.

\*\* Photos that were captured without inserting a memory card cannot be transferred to a memory card or a computer.

## 2. Shooting options

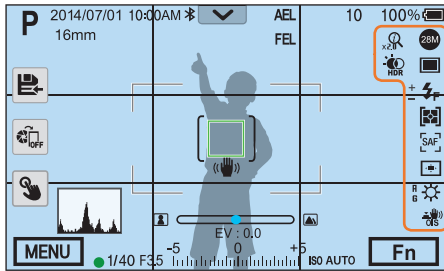

Icon	Description
	Photo size
	RAW file
	Drive mode
	Flash (p. 116)
	Flash intensity adjustment
	Metering (p. 122)
	AF mode (p. 98)
	Focus area
	Face detection

Icon	Description
	White Balance (p. 94)
	White Balance micro adjustment
	Optical Image Stabilization (OIS) (p. 109)
	intelli-zoom on
	intelli-zoom ratio
	Dynamic Range (p. 125)
	Headset connected

## 3. Shooting options (Touch)

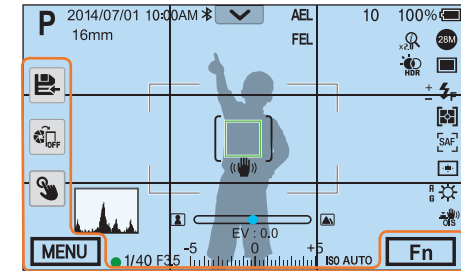

Icon	Description
	Change Smart mode*
	Save a custom mode
	Quick Transfer (p. 161)
	Touch AF options
	Shooting options
	Smart panel

\* This icon appears only when you select Smart mode.



The icons displayed will change according to the mode you select or the options you set.

## Recording videos

### 1. Shooting information

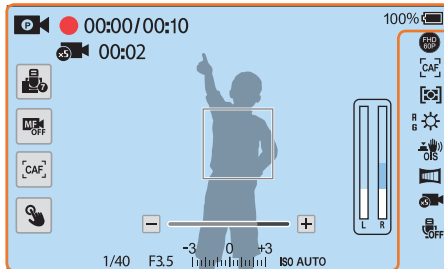

Icon	Description
	Shooting mode
	Mic level (Touch)
	Switch between AF and MF. (Touch)
	Switch between Single AF and Continuous AF. (Touch)
	Touch AF option (Touch)
00:00/ 00:10	Current recording time/ Available recording time
	Fast / Slow Movie (p. 133)
00:02	Playback time after applying the Fast / Slow Movie feature
100%	Battery percentage
	<ul style="list-style-type: none"> <li>: Fully charged</li> <li>: Partially charged</li> <li>: Empty (recharge the battery)</li> <li>: Charging</li> <li>: Internal battery in use (when the vertical grip is connected)</li> <li>: External battery in use (when the vertical grip is connected)</li> </ul>

Icon	Description
	Zoom indicator*
	Exposure value
ISO AUTO	ISO sensitivity (p. 91)
	Video sound level

\* This icon appears when you attach the Power Zoom lens.

## 2. Shooting options

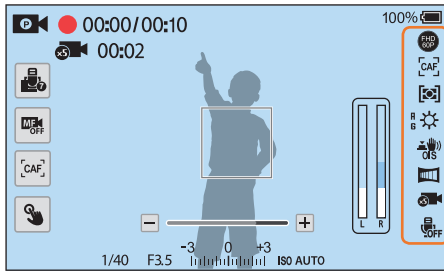

Icon	Description
	Video size
	AF mode (p. 98)
	Metering (p. 122)
	External microphone is connected
	White Balance (p. 94)
	White Balance micro adjustment

Icon	Description
	Optical Image Stabilization (OIS) (p. 109)
	Fader (p. 136)
	Fast / Slow Movie (p. 133)
	Voice recording off (p. 136)
	Zoom button*

\* This icon appears when you attach the Power Zoom lens.



The icons displayed will change according to the mode you select or the options you set.

## About the level gauge

The level gauge helps you align the camera with the horizontal and vertical lines on the display. If the level gauge is not level, calibrate the level gauge using the Horizontal Calibration function. (p. 192)

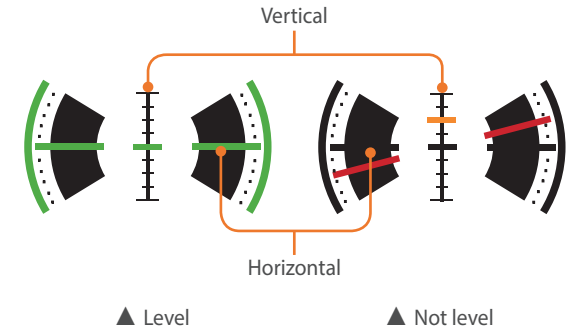

## In Playback mode

### Viewing photos

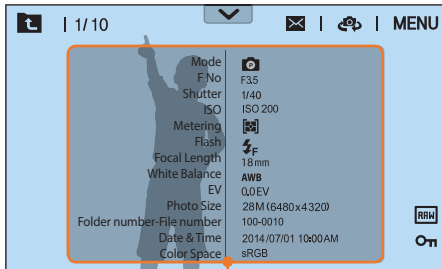

Information

Icon	Description
	View image thumbnails. (Touch)
1/10	Current file/The total number of files
	Notification panel bar (Touch)
	Send photos via email. (Touch)
	Share files with other devices. (Touch)
MENU	Playback/Editing/Setting menu (Touch)
	RAW file
3D	3D file
	Protected file

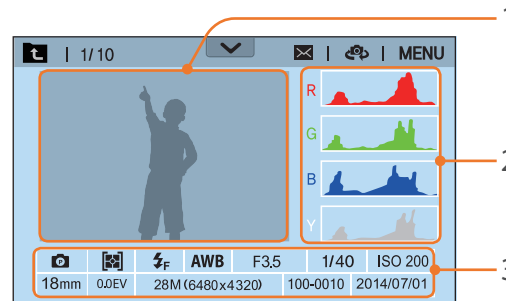

No.	Description
1	Captured photo
2	RGB histogram (p. 127)
3	Shooting mode, Metering, Flash, White Balance, Aperture value, Shutter speed, ISO, Focal length, Exposure value, Photo size, Folder number-File number, Date

### Playing videos

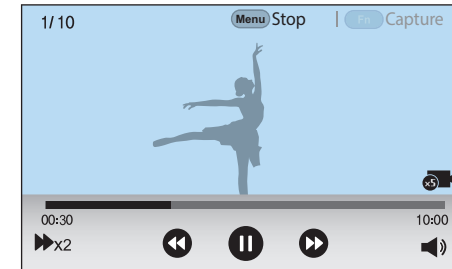

Icon	Description
	Playback speed
00:30	Current playback time
10:00	Video length
	Fast / Slow Movie
	View previous file/Scan backward. (Each time you touch the scan backward icon, you change the scan speed in this order: 2X, 4X, 8X.)
	Pause or resume playback.
	View next file/Scan forward. (Each time you touch the scan forward icon, you change the scan speed in this order: 2X, 4X, 8X.)
	Adjust the volume or mute the sound.

## Changing the information displayed

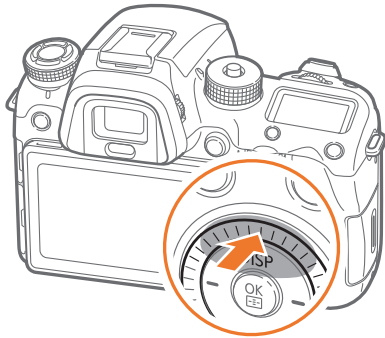

Press [DISP] repeatedly to change the display type.

Mode	Display type
<b>Shooting</b>	• Basic shooting information + Shooting option buttons + Current shooting options information
	• Basic shooting information (Shooting mode, Shutter speed, Aperture value, Exposure value, ISO sensitivity, etc.)
	• Basic shooting information + Shooting option buttons (MENU, Fn, Quick Transfer, Touch AF, Custom mode save) + Current shooting options information (Photo size, Drive mode, Flash, Metering, AF mode, etc.) + Histogram
	• Basic shooting information + Shooting option buttons + Current shooting options information + Level gauge
	• No information (when connected to an HDMI-supported TV or monitor)
<b>Playback</b>	• Basic information
	• Display all information about the current file.
	• Display all information about the current file including RGB histogram.



## Viewing the status display window

View basic shooting information, such as AF mode, metering option, and battery life on the status display window without having to view the display. Press [Fn] to illuminate the status display window.

### Capturing photos or recording videos

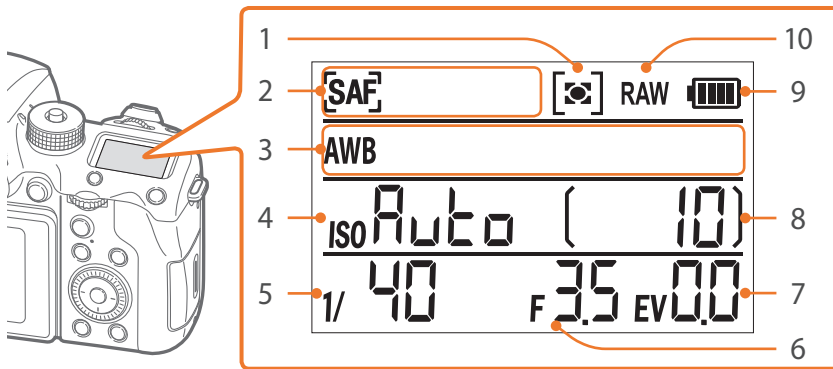

No.	Description
1	Metering (p. 122)
2	AF mode (p. 98)
3	White Balance (p. 94)
4	ISO sensitivity (p. 91)
5	Shutter speed
6	Aperture value

No.	Description
7	Exposure adjustment value
8	Available number of photos
9	Battery life
10	RAW file

### Connecting to a computer



When connected to a computer via USB cable

### Charging batteries



When charging the internal battery (the camera)



When charging the external battery (vertical grip)

## Viewing the notification panel

Touch  at the top of the display to open the notification panel. You can adjust the display brightness or view the current date and time, battery life, and data storage information. You can also view the status of a Bluetooth or Wi-Fi connection and enable or disable it. If a new version of firmware is available when the camera is connected to a Wi-Fi network, the notification panel bar blinks and a notification appears at the upper right corner of the notification panel. Touch the bottom of the notification panel or press [MENU] or [Fn] to close it.

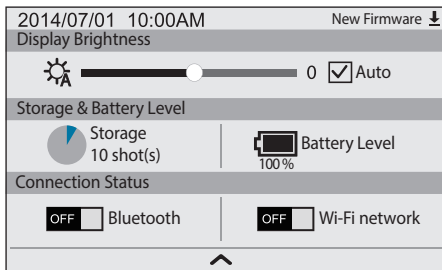

# Lenses

You can purchase optional lenses made exclusively for your NX series camera.

Learn about the functions of each lens and select one that suits your needs and preferences.

## Lens layout

SAMSUNG 16-50mm F2-2.8 S ED OIS lens (example)

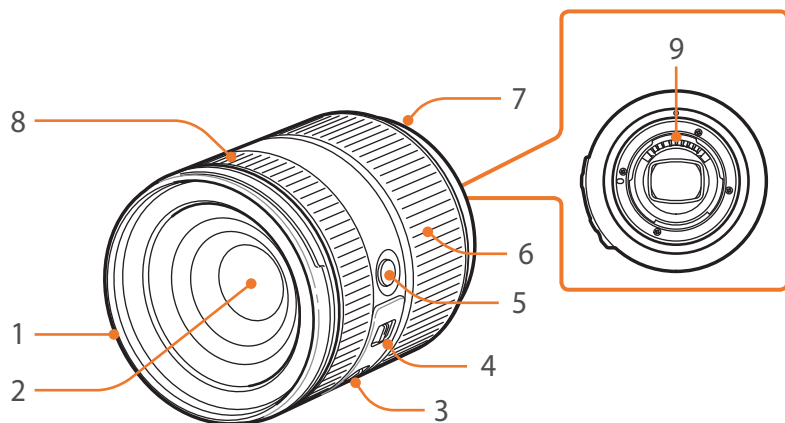

No.	Description
1	Lens hood mount index
2	Lens
3	OIS switch
4	AF/MF switch (p. 98)
5	i-Function button (p. 48)
6	Zoom ring
7	Lens mount index
8	Focus ring (p. 106)
9	Lens contacts*

\* Avoid contact with or prevent damage to the lens contacts.



When not using the lens, attach the lens cap and lens mount cover to protect the lens from dust and scratches.

SAMSUNG 20-50mm F3.5-5.6 ED II lens (example)

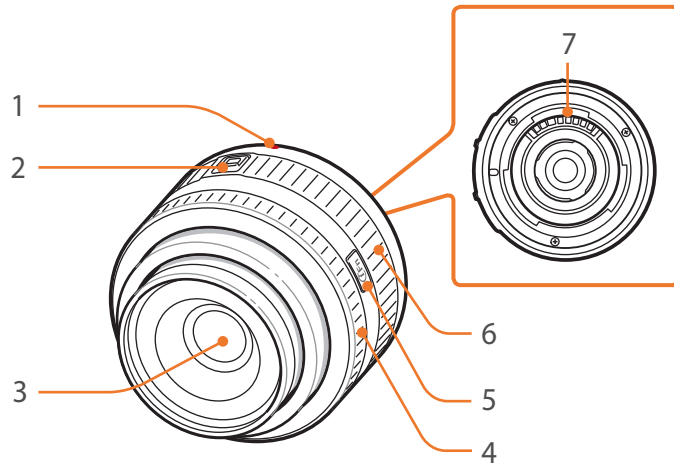

Locking or unlocking the lens

To lock the lens, slide and hold the zoom lock switch away from the camera body, and then rotate the zoom ring as shown in the illustration.

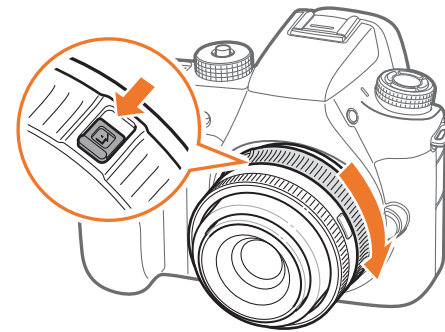

No.	Description
1	Lens mount index
2	Zoom lock switch
3	Lens
4	Focus ring (p. 106)
5	i-Function button (p. 48)
6	Zoom ring
7	Lens contacts*

\* Avoid contact with or prevent damage to the lens contacts.

To unlock the lens, rotate the zoom ring as shown in the illustration until you hear the click.

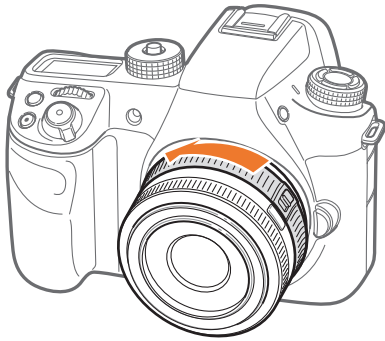

You cannot capture a photo when the lens is locked.

### NX 50-150mm F2.8 S ED OIS lens (example)

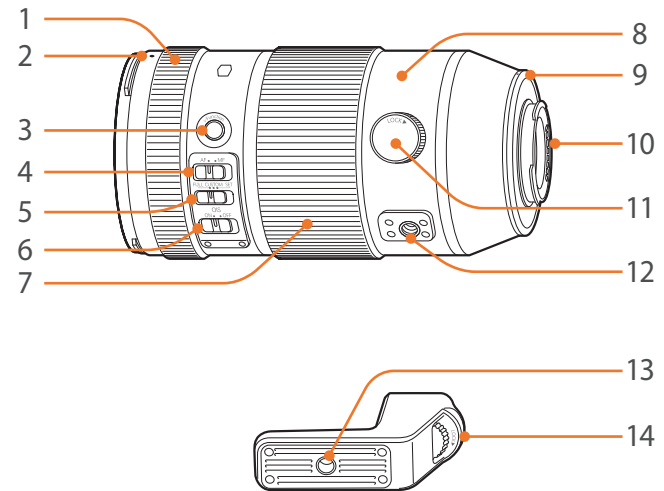

No.	Description
1	Focus ring (p. 106)
2	Lens hood mount index
3	i-Function button (p. 48)
4	AF/MF switch
5	Custom Focus Range Limiter switch
6	OIS switch

No.	Description
7	Zoom ring
8	Tripod ring
9	Lens mount index
10	Lens contacts*
11	Tripod ring locking dial
12	Tripod collar connection
13	Tripod connection
14	Tripod mount collar lock dial

\* Avoid contact with or prevent damage to the lens contacts.

### Using the Custom Focus Range Limiter Function

You can adjust the focus quickly and precisely by setting the range for the focus distance.

1 Set the Custom Focus Range Limiter switch to **SET**.

2 Set a focus range.

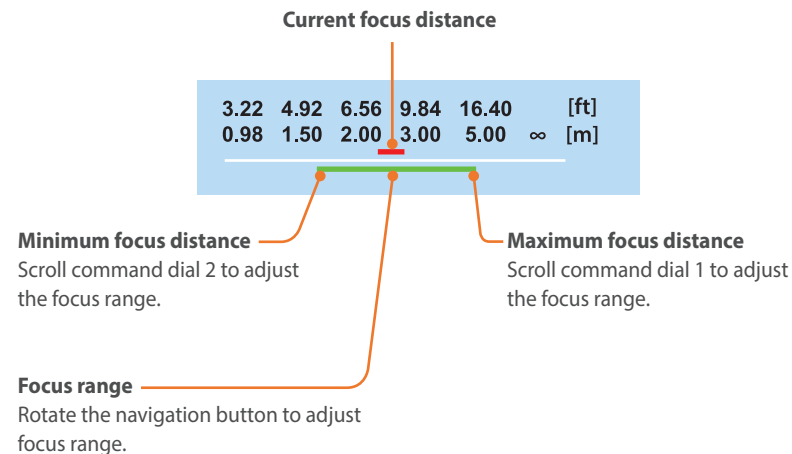

The illustration above may differ from the actual screen on your camera.

3 Set the Custom Focus Range Limiter switch to **CUSTOM** and capture a photo.

## Lens markings

Find out what the numbers on the lens signify.

### SAMSUNG 18-200mm F3.5-6.3 ED OIS lens (example)

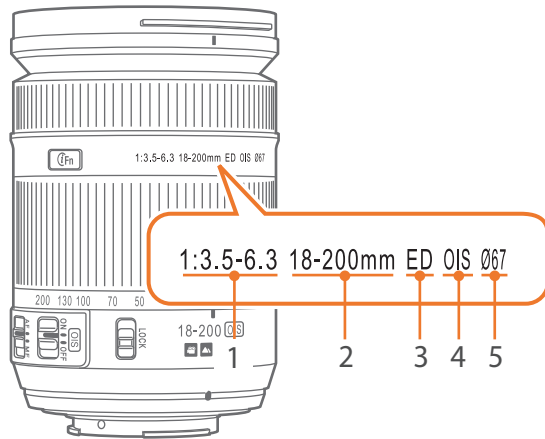

No.	Description
1	<p><b>Aperture value</b></p> <p>A range of supported aperture values. For example, 1:3.5–6.3 means the aperture range is 3.5 to 6.3.</p>
2	<p><b>Focal length</b></p> <p>The distance from the middle of the lens to its focal point (in millimeters). This figure is expressed in a range: the minimum focal length to the maximum focal length of the lens.</p> <p>Longer focal lengths result in narrower angles of view and the subject is magnified. Shorter focal lengths result in wider angles of view.</p>
3	<p><b>ED</b></p> <p>ED stands for Extra-low Dispersion. Extra-low dispersion glass is effective in minimizing chromatic aberration (a distortion that occurs when a lens fails to focus all colors to the same convergence point).</p>
4	<p><b>OIS (p. 109)</b></p> <p>Optical Image Stabilization. Lenses with this feature can detect camera shake and effectively cancel out the movement inside the camera.</p>
5	<p><b>Ø</b></p> <p>The lens diameter. When you attach a filter to the lens, make sure that the diameters of the lens and the filter are the same.</p>

You can use an external flash that can help you capture better photos.

You can use the vertical grip to conveniently capture photos in portrait orientation. Also, the external battery capability provides more shooting time.

You can use the battery charger to charge the battery.



- The illustrations may differ from the actual items.
- You can purchase Samsung-approved accessories at a retailer or a Samsung service center. Samsung is not responsible for damage caused by using another manufacturer's accessories.

## External flash layout

### SEF-580A (example) (optional)

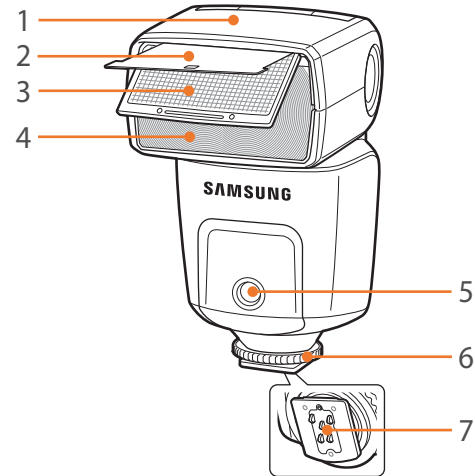

No.	Description
1	Flash head
2	Reflector card
3	Wide-angle panel
4	Lamp
5	AF-assist light
6	Hot-shoe fastening dial
7	Hot-shoe connection



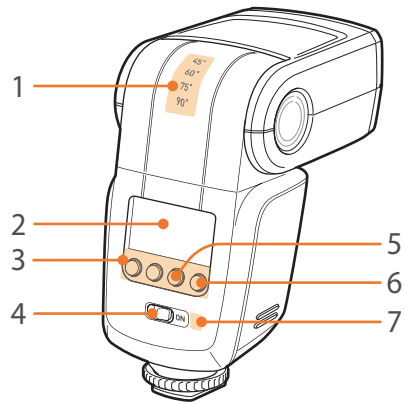

No.	Description
1	Flash head angles
2	Flash screen
3	Flash buttons
4	Power switch
5	Correct exposure indicator
6	Manual firing button/Flash-ready indicator
7	Light sensor for wireless remote flash

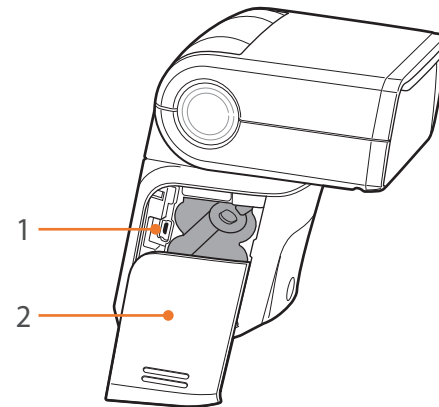

No.	Description
1	USB port
2	Battery chamber cover

### Connecting the external flash

1 Remove the hot-shoe cover from the camera.

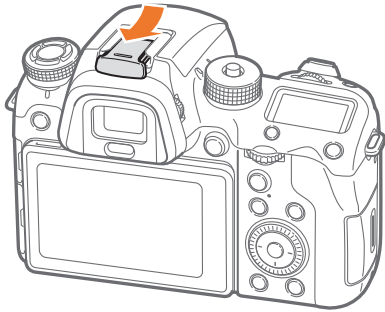

2 Mount the flash by sliding it into the hot-shoe.

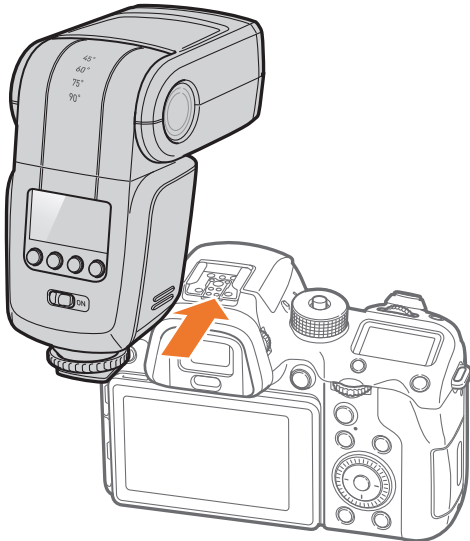

3 Rotate the hot-shoe fastening dial as shown in the illustration to lock the flash into place.

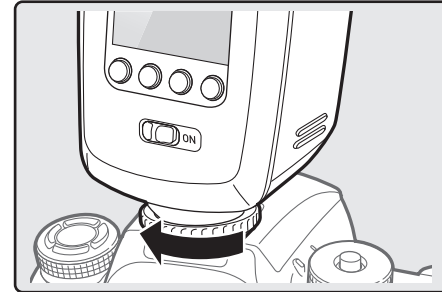

4 Slide the power switch towards **ON** to turn on the flash.



- You can capture a photo with a flash that is not fully charged, but it is recommended to use a fully charged flash.
- The available options may differ depending on the shooting mode.
- There is an interval between two bursts of the flash. Do not move until the flash fires a second time.
- For more details about optional flashes, refer to the user manual for the flash.



Use only Samsung-approved flashes. Using incompatible flashes may damage your camera.

## Vertical grip layout

ED-VGNX01 (example) (optional)

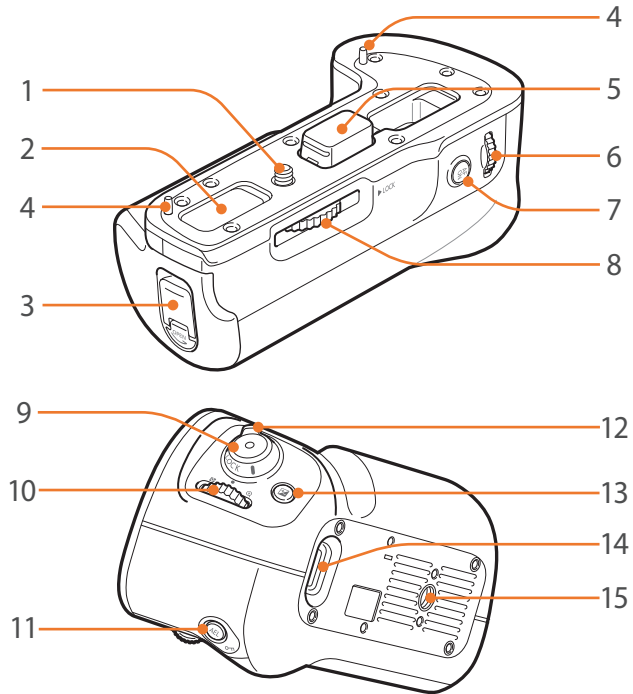

No.	Description
1	Mounting screw
2	Contact cover recess (for the camera body)
3	Battery compartment locking lever
4	Camera guide pin
5	Electrical connection cover
6	Command dial 2
7	AF start button
8	Vertical grip locking dial
9	Shutter button
10	Command dial 1
11	AEL button
12	Vertical grip locking switch
13	EV button
14	Eyelet for camera strap
15	Tripod mount

### Inserting the battery

- 1 Flip down the battery compartment locking lever and turn it as shown in the illustration, and then remove the battery compartment.

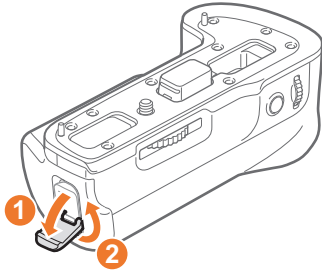

- 2 Insert a battery into the battery compartment.
  - Insert the battery with the gold-colored contacts facing up as shown in the illustration.

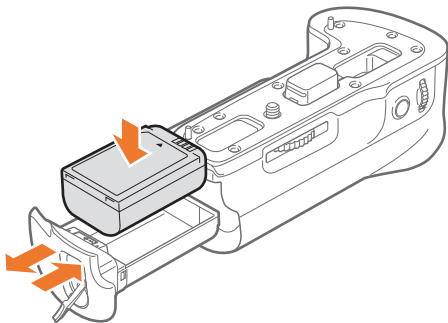

- 3 Insert the battery compartment into the vertical grip and then close the battery chamber locking lever as shown in the illustration.

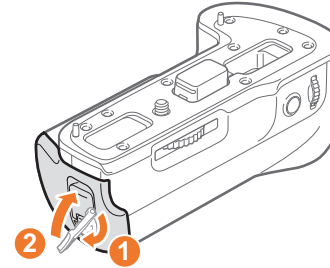

### Attaching to the camera

- 1 Open the electrical connection cover.

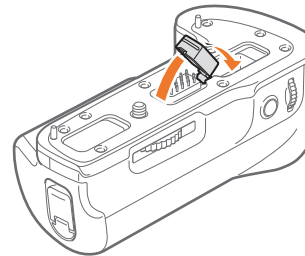

- 2 Align the electrical contacts, the mounting screw, and the camera guide pin with the bottom of the camera.

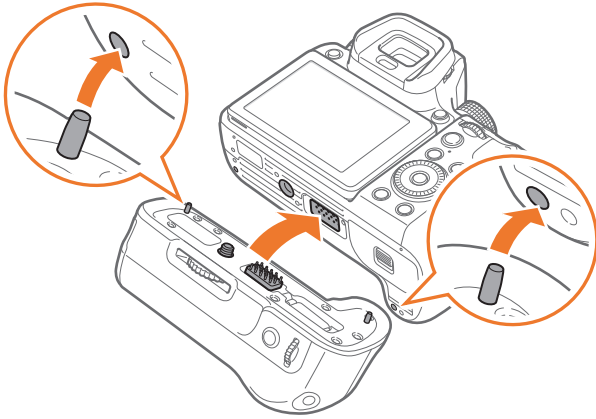

- 3 Lock the vertical grip in place by turning the vertical grip locking dial to LOCK.

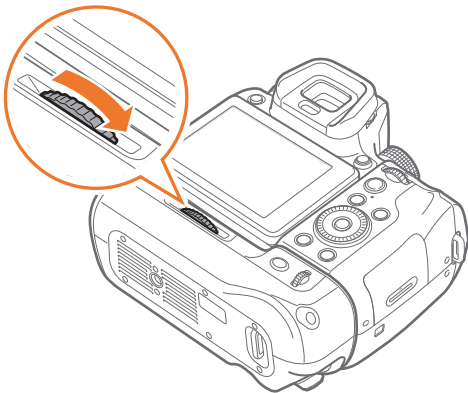

Before attaching the camera to the vertical grip, turn the camera off. The camera may not operate properly if you attach it while it is turned on.



- Do not expose the device to water.
- Avoid removing or changing the device in dusty areas.
- This product is not water or dust proof. Exposure to severe conditions is not recommended.

## Battery charger

ED-BC4NX03 (example) (optional)

### Status lamp

- **Red light on:** Charging
- **Green light on:** Fully charged
- **Orange light blinking or on/lamp off:** Error

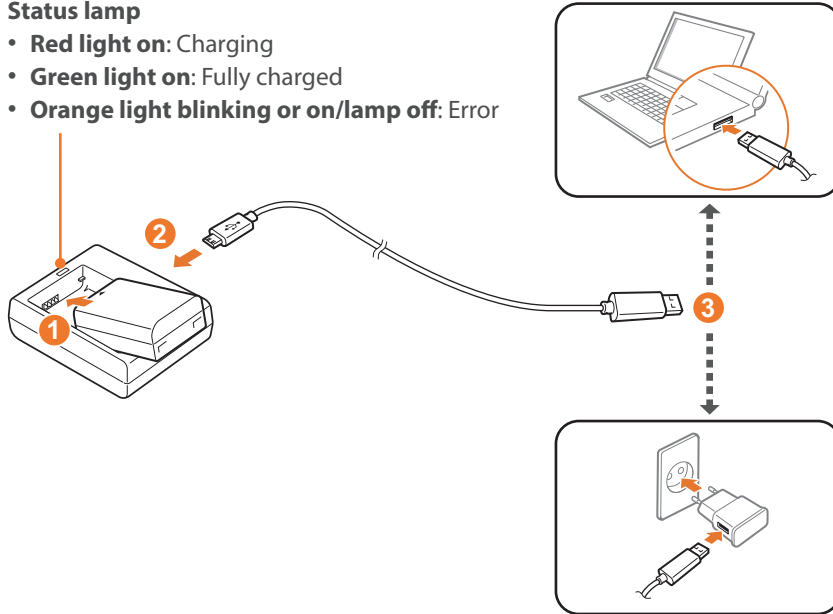

### Charging the battery

- 1 Insert battery. (1)
- 2 Plug the small end of the USB cable into the charger. (2)
- 3 Plug the other end of the USB cable into the power adapter or the USB port of your computer. (3)



Use the USB cable and the power adapter that are included in your camera's product box.

# Shooting modes

Two simple shooting modes—Auto and Smart mode—help you capture photos with numerous automatic settings. Additional modes allow for greater customization of settings.



Do not rotate the mode dial if the mode dial lock button is pressed. Doing so may damage the camera.

Icon	Description
<b>AUTO</b>	Auto mode (p. 70)
P	Program mode (p. 72)
A	Aperture Priority mode (p. 74)
S	Shutter Priority mode (p. 75)
M	Manual mode (p. 76)
C <sub>1</sub>	Custom1 mode (p. 77)
C <sub>2</sub>	Custom2 mode (p. 77)
<b>S</b>	Smart mode (p. 79)

## **AUTO** Auto mode

In Auto mode, the camera recognizes surrounding conditions and automatically adjusts factors that contribute to exposure, including shutter speed, aperture value, metering, White Balance, and exposure compensation. As the camera controls most of the functions, some shooting functions are limited. This mode is useful for capturing quick snapshots with the least amount of adjustment.



- 1 Rotate the mode dial to **AUTO**.
- 2 Align your subject in the frame.

### 3 Half-press [Shutter] to focus.

- The camera selects a scene. An appropriate scene icon appears on the screen.

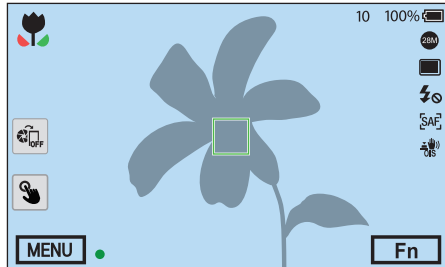

### Recognizable scenes

Icon	Description
	Landscapes
	Scenes with bright white backgrounds
	Landscapes at night
	Portraits at night
	Landscapes with backlighting
	Portraits with backlighting
	Portraits
	Close-up photos of objects
	Close-up photos of text

Icon	Description
	Sunsets
	Indoors, dark
	Partially lit
	Close-up with spot lighting
	Portraits with spot lighting
	Blue skies
	Forested areas typically consist of green-colored subjects
	Close-up photos of colorful subjects
	Camera is stabilized on a tripod and the subject is not moving for a certain period of time. (when shooting in the dark)
	Actively moving subjects

### 4 Press [Shutter] to capture the photo.



- The camera may select different scenes and adjust settings differently, even when you aim at the same subject. Scene selection depends on external factors, such as camera shake, lighting, and distance to the subject.
- If the camera does not recognize an appropriate scene mode, it uses the default settings for the Auto mode.
- Even if it detects a face, the camera may not select a portrait mode depending on the subject's position or lighting.
- Even if you use a tripod, the camera may not detect the tripod mode if the subject is moving.
- The camera consumes more battery power, because it changes settings often to select appropriate scenes.



## P Program mode

The camera automatically adjusts shutter speed and aperture value so that an optimal exposure value can be achieved.

This mode is useful when you want to capture shots of constant exposure while being able to adjust other settings.



- 1 Rotate the mode dial to P.
- 2 Set the desired options.
- 3 Half-press [**Shutter**] to focus, and then press [**Shutter**] to capture the photo.

### Program Shift

The Program Shift function lets you adjust the shutter speed and aperture value while the camera maintains the same exposure. When you scroll command dial 1 or command dial 2 to the left, the shutter speed decreases and the aperture value increases. When you scroll command dial 1 or command dial 2 to the right, the shutter speed increases and the aperture value decreases.

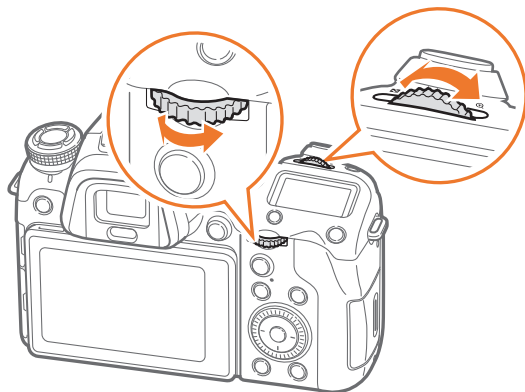

Direction	Adjustable item
←	Shutter speed decreases and aperture value increases.
→	Shutter speed increases and aperture value decreases.



You can also set other functions and set the direction of operation for command dials 1 and 2. (p. 187)

### Minimum shutter speed

Set the shutter speed not to be slower than the selected speed. However, if an optimal exposure value cannot be achieved because the ISO sensitivity reached the maximum ISO value that is set by Auto ISO Range, shutter speed may be slower than the selected minimum shutter speed.

To set the minimum shutter speed,

In Shooting mode, press [MENU] → → **Minimum Shutter Speed** → an option.



- If you select **Auto (link to focal length)**, the camera will automatically set a minimum shutter speed based on the lens' focal length. Scroll to **Auto (link to focal length)**, and then press [=] (right) to decrease or increase the minimum shutter speed.
- This feature is available only when ISO sensitivity is set to Auto.
- This feature is available only in Program or Aperture Priority mode.

## A Aperture Priority mode

In Aperture Priority mode, the camera automatically calculates shutter speed according to the aperture value you choose.

You can adjust the depth of field (DOF) by changing the aperture value. This mode is useful for taking portraits, flowers, or landscape shots.



Large Depth of Field

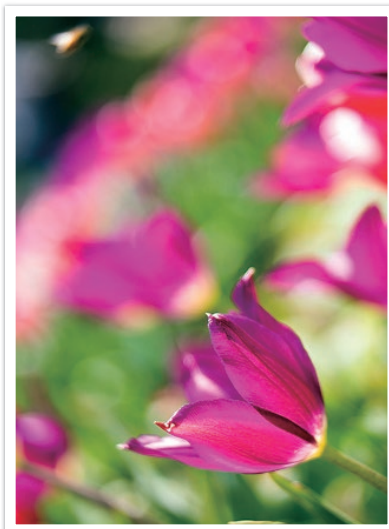

Small Depth of Field

- 1 Rotate the mode dial to **A**.
- 2 Scroll command dial 1 or command dial 2 to adjust the aperture value.
  - You can also set other functions and set the direction of operation for command dials 1 and 2. (p. 187)
  - You can also adjust the aperture value by pressing [Fn], moving to the aperture value, and then scrolling command dial 1 or dragging your finger on the screen.
- 3 Set the desired options.
- 4 Half-press [**Shutter**] to focus, and then press [**Shutter**] to capture the photo.



- In low-light settings, you may need to increase the ISO sensitivity to prevent blurred photos.
- To set the minimum shutter speed, in Shooting mode, press [MENU] → [Camera icon] → **Minimum Shutter Speed** → an option.

## S Shutter Priority mode

In Shutter Priority mode, the camera automatically adjusts the aperture value according to the shutter speed you choose. This mode is useful for capturing photos of fast-moving subjects or for creating tracer effects in a photo.

For example, set the shutter speed to over 1/500 s to freeze the subject. To make the subject appear blurred set the shutter speed to below 1/30 s.

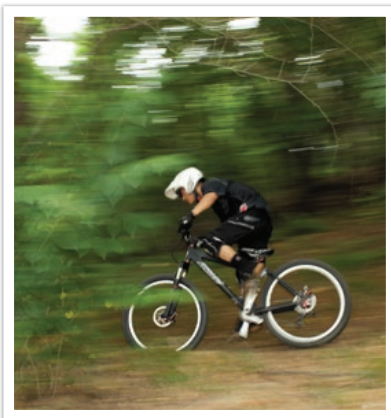

Slow shutter speed

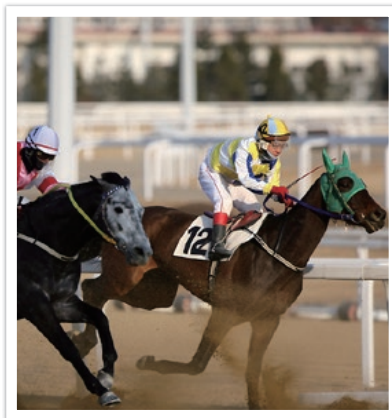

Fast shutter speed

- 1 Rotate the mode dial to S.
- 2 Scroll command dial 1 or command dial 2 to adjust the shutter speed.
  - You can also set other functions and set the direction of operation for command dials 1 and 2. (p. 187)
  - You can also adjust the shutter speed by pressing [Fn], moving to the shutter speed, and then scrolling command dial 1 or dragging your finger on the screen.
- 3 Set the desired options.
- 4 Half-press [**Shutter**] to focus, and then press [**Shutter**] to capture the photo.



To compensate for the reduced amount of light allowed by fast shutter speeds, open the aperture and let in more light. If your photos are still too dark, increase the ISO value.

## M Manual mode

Manual mode lets you adjust the shutter speed and aperture value manually. In this mode, you can fully control the exposure of your photos.

This mode is useful in controlled shooting environments, such as a studio, or when it is necessary to fine-tune camera settings. The Manual mode is also recommended for shooting night scenes or fireworks.

- 1 Rotate the mode dial to **M**.
- 2 Scroll command dials 1 and 2 to adjust the shutter speed and aperture value, respectively.
  - You can also set other functions and set the direction of operation for command dials 1 and 2. (p. 187)
  - You can also adjust the shutter speed or the aperture value by pressing [Fn], moving to the shutter speed or the aperture value, and then scrolling command dial 1 or dragging your finger on the screen.
- 3 Set the desired options.
- 4 Half-press [**Shutter**] to focus, and then press [**Shutter**] to capture the photo.

### Using the Bulb function

Use the Bulb function to shoot night scenes or the night sky. While you press and hold [**Shutter**], the shutter remains open so you can create moving light effects. To close the shutter, release [**Shutter**].

To use the Bulb function,

Completely scroll command dial 1 to the left to **Bulb** → press and hold [**Shutter**] for the desired time.







- If you set a high ISO value or open the shutter for a long time, image noise may increase.
- Drive options, flash, and One touch shot cannot be used with the Bulb function.
- The Bulb function is available only in Manual mode.
- Use a tripod and shutter release to prevent your camera from shaking.
- The longer you open the shutter, the longer it takes to save a photo. Do not turn the camera off while the camera saves a photo.
- To use this function for an extended period, make sure the battery is fully charged.

## C1 C2 Custom mode

Custom mode lets you create your own shooting modes by customizing options and saving them. Save frequently used option settings as a named Custom Mode, and then use it as your own shooting mode customized for the shooting environment. Use custom mode when you capture photos in various environments, you have preferred shooting settings, or you frequently use preset options in certain conditions.

### Saving custom modes

- 1 Rotate the mode dial to P, A, S, M, C1, or C2.
- 2 Set shooting options.
- 3 Press [MENU], and then select  → **Manage Custom Mode** → **Save**.
  - You can also save a custom mode by touching  → **Save** on the screen.
  - You can also save a custom mode by pressing [Fn], and then touching .

- 4 Verify the shooting options, and then select **Save** or **Save as**.
- 5 Use the on-screen keyboard to enter a name for the mode. (p. 167)
- 6 Press [>] to save the mode name.
- 7 Capture a representative photo for the mode to save.
- 8 Select **Save**.



You can save up to 40 custom modes.

### Downloading custom modes

You can download various shooting settings (film) to a smart phone and share them with the camera.

- 1 Connect the camera and a smart phone via Bluetooth.
- 2 On the smart phone, turn on Samsung Camera Manager.
- 3 Select **Pro Suggest Market**.
- 4 Download a desired film.
  - Downloaded films are saved to the camera as custom modes.



- The custom mode saved on the camera is automatically shared to a smart phone when the camera and a smart phone are connected.
- Some of the shooting settings (film) may not be supported on the camera.

### Selecting custom modes

- 1 Rotate the mode dial to **C1** or **C2**.
- 2 On a pop-up window, select **Yes** → a mode.
  - You can also press [MENU], and then select ⌘ → **Manage Custom Mode** → **Open** → a mode.
  - You can also touch  on the screen and select **Open** → a mode.
  - If there are no custom modes saved, you can select a shooting mode from a pop-up window on the camera, set shooting options, and then save new custom modes.
- 3 Verify the shooting options, and then select **OK**.

### Deleting custom modes

- 1 Rotate the mode dial to **P**, **A**, **S**, **M**, **C1**, or **C2**.
- 2 Press [MENU], and then select ⌘ → **Manage Custom Mode** → **Delete** → **Multiple Delete**.
  - To delete all the saved custom modes, select **Delete All**, and then select **Yes** when the pop-up message appears.
- 3 Select a mode to delete, and then press [].

## S Smart mode

In Smart mode, you can capture photos with preset parameters when shooting specific scenes, conditions, or effects.

1 Rotate the mode dial to **S**.

2 Select a scene.

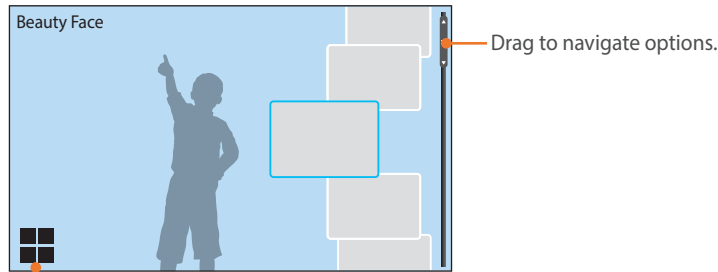

Switch to the grid view.

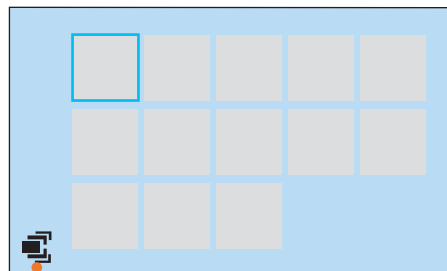

Switch to the list view.

Option	Description
<b>Beauty Face</b>	Capture a portrait with options to hide facial imperfections.
<b>Landscape</b>	Capture still-life scenes and landscapes.
<b>Action Freeze</b>	Capture subjects moving at high speed.
<b>Rich Tones</b>	Capture a photo with vibrant colors.
<b>Panorama</b>	Capture a wide panoramic scene in a single photo.
<b>Waterfall</b>	Capture scenes with waterfalls.
<b>Multi Exposure</b>	Capture multiple photos and overlap them to create one photo.
<b>Samsung Auto Shot</b>	Capture action photos, such as someone hitting a baseball, a jumpshot, or when the subject passes a preset point.
<b>Silhouette</b>	Capture subjects as dark shapes against a light background.
<b>Sunset</b>	Capture scenes at sunset, with natural-looking reds and yellows.



Option	Description
<b>Night</b>	Capture a photo with less blurring and visual noise.
<b>Fireworks</b>	Capture scenes with fireworks.
<b>Light Trace</b>	Capture scenes with the light trailing in low-light conditions.

Some options are not available when you use the viewfinder.

- 3 Half-press [**Shutter**] to focus, and then press [**Shutter**] to capture.



### Capturing panoramic photos

In Panorama mode, you can capture a wide panoramic scene in a single photo. Panorama mode captures and combines a series of photos to create a panoramic image.

1 Rotate the mode dial to **S**, and then select **Panorama**.

2 Press and hold [**Shutter**] to start shooting.

3 With [**Shutter**] pressed, slowly move the camera in the direction you selected.

- An arrow pointing in the direction of motion is displayed, and the entire shooting image is displayed in the preview box.
- When the scenes are aligned, the camera captures the next photo automatically.



4 When you are finished, release [**Shutter**].





- The camera will automatically save the shots into one photo.
- If you release [**Shutter**] while shooting, the panoramic shooting stops and photos that have been captured are saved.



- The resolution varies depending on the panoramic photo you captured.
- In Panorama mode, some shooting options are not available.
- The camera may stop shooting due to the shooting composition or the subject's movement.
- In Panorama mode, if you stop moving the camera when the end of the scene appears in the camera's screen or viewfinder, the camera may not capture the entire scene, in order to improve the photo quality. To capture the entire scene, move your camera slightly beyond the point where you want the scene to end.
- For best results when capturing panoramic photos, avoid the following:
  - moving the camera too quickly or too slowly
  - moving the camera too little to capture the next image
  - moving the camera at irregular speeds
  - shaking the camera
  - shooting in dark places
  - capturing moving subjects nearby
  - shooting conditions where the brightness or color of light is changing
- Photos taken are automatically saved, and shooting is stopped under the following conditions:
  - If you change the shooting direction while shooting.
  - If you move the camera too rapidly.
  - If you do not move the camera.

### Using the Samsung Auto Shot mode

In Samsung Auto Shot, you can capture action photos, such as someone hitting a baseball, a jumpshot, or when the subject passes a preset point.

- 1 Rotate the mode dial to , and then select **Samsung Auto Shot**.
- 2 Touch , , or , and then select **Baseball, Jump Shot, or Trap Shot**.
- 3 Press [**Shutter**] to capture a photo.
  - The camera takes photos continuously when it detects the subject's movement.
  - Press [**MENU**] to stop capturing.



- Use a tripod to prevent your camera from shaking.
- In dark environments, the camera may not capture the movements of subjects properly.
- You can only select a 3:2 photo size.

### When Jump Shot is selected

Focus on the subject and start capturing. The camera automatically takes the photo when it detects the jumping subject at its highest point. You can also select and focus on an area that you touch on the screen.



- The camera may take the photo using the person jumping highest as a reference when many people are jumping.
- The camera may not take the photo properly under the following conditions:
  - The height of the subject is less than 50 % of the angle of view from the vertical reference.
  - The jumping action is not sufficiently distinct to be recognized by the camera.

## When Baseball is selected

The camera automatically takes the photo when it detects a ball at the estimated hitting point that you set.

To position the vertical line on the hitting point, drag the vertical line on the screen, scroll command dial 1 or 2, or rotate the navigation button.

To change the location of the batter and the ball, tap and drag the vertical line to the batter's location facing the pitcher. You cannot drag the line into the opaque area on the screen.

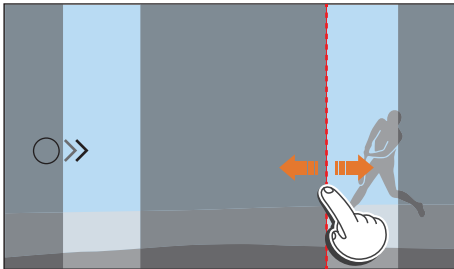

- The camera may not take the photo properly under the following conditions:
  - When shooting outside of a  $\pm 20^\circ$  angle of view from a batter's side (in the direction of a ball's path).
  - When the estimated hitting point is outside of the selectable area.
  - If there is a net or fence between you and the subject.
- The camera may take a photo even when it does not detect a ball, such as when the subject is backlit, when you take photos indoors, or when you take photos without using a tripod.

## When Trap Shot is selected

The camera takes photos continuously when it detects the subject moving in the direction of the arrow at the line that you set.



To position the vertical line on the screen, drag the arrow icon on the vertical line to the desired point, and scroll command dial 1 or 2, or rotate the navigation button.

You can also touch the area on the screen where the subject is expected to pass through or manually adjust the focus by rotating the focus ring after half-pressing [**Shutter**].



- When you select Trap Shot, the Direct Manual Focus (DMF) function is automatically set.
- When you select Trap Shot, the AF mode is set to Single AF and the AF area is set to Selection AF.
- The area where the subject is expected to pass through must be in focus.
- You cannot drag the line into the opaque area of the screen.
- Subjects that are moving in the same direction may not be detected properly depending on the angle of view or the size of the subjects.
- The camera may not take the photo properly under the following conditions:
  - When the size of the subject is too small.
  - When the subject is moving quickly.
  - When there are moving objects in the background.
  - When you take photos in dark, indoor areas, such as an indoors sports complex.

## Recording a video

In Shooting mode, you can record UHD videos (up to 4096X2160) by pressing  (Video recording). (p. 205) The camera saves video in HEVC format. To view HEVC files, you must have a device or program with HEVC codecs installed. Sound is recorded via the camera's microphone. (If you attach an external microphone, the sound will be recorded via the external microphone.) You can set the mic level by touching  when recording a video.

You can set the exposure by adjusting the aperture value and shutter speed for the mode you selected. When you use a lens that does not have an AF/MF switch while recording a video, press [**AF**] to select a desired AF mode. If the lens has an AF/MF switch, set the switch according to the selected focus mode. Set the switch to AF when you select Single AF or Continuous AF. Set the switch to MF when you select Manual Focus.

Press the AF start button to switch between AF and MF and press [**Fn**] to switch between Single AF and Continuous AF while recording a video. Press the AEL button to use the focus lock function (when the AFL function is assigned to the AEL button).

Select **Fader** to fade a scene in or out. You can also select **Voice, Wind Cut**, or other options. (p. 136)

While recording a video, touch  to select a touch AF option. If you select **Touch AF**, you can hold the camera's focus on a subject by touching the subject on the screen. If you select **Tracking AF**, the focus tracks and automatically focuses on your subject, even when the subject is moving or when you change the picture composition.

### 1 Set the desired options.

- If [**-/I/-**] is set to **Movie STBY**, press [**-/I/-**] to enter the Video recording standby mode.

### 2 Press (Video recording) to start recording.

- Video recording may not be supported depending on the selected shooting options.

### 3 Press (Video recording) again to stop.



- High-efficiency Video Coding (HEVC) is the latest video encoding format established in 2013 collaboratively by ISO-IEC and ITU-T. Because this format uses a high compression rate, more data can be saved in less memory space. Depending on your computer's specifications and interface, files may not play at full resolution due to the high compression rate on some computers. To view the file in HEVC format, you need a device or program that installed HEVC codecs.
- If you have the image stabilizer option on when shooting a movie, the camera may record the sound of the image stabilizer working.
- When recording a video, the camera may record the sounds of the zoom or other lens adjustments.
- When using an optional video lens, the autofocus noise is not recorded.
- If you remove the camera lens while recording a movie, the recording will be interrupted. Do not change the lens while recording.
- If you attach an external microphone while recording, sound will be recorded via the external microphone. If you remove the external microphone while recording, sound will be recorded via the camera's microphone.
- You can set the ISO sensitivity up to ISO 6400 when recording a video.

- Audio recorded via an external microphone may differ in tone and quality from audio recorded with the camera's microphone.
- If you change the shooting angle of the camera suddenly while shooting a movie, the camera may not be able to record images accurately. Use a tripod to minimize camera shake.
- When formatting a memory card, always format using the camera. When you format a memory card with a capacity of 32 GB or less on the camera, the file system is changed to FAT32. When you format a memory card with a capacity of 64 GB or more, the file system is changed to exFAT. If you format on another camera or a PC, you can lose files on the card or cause a change in the capacity of the card.
- When using a memory card formatted as FAT32, the camera will automatically stop recording when the size of a video exceeds 4 GB, even if the maximum recording time (29 minutes and 59 seconds) has not been reached. Using a memory card formatted as exFAT allows you to record a video for the maximum recording time (29 minutes and 59 seconds), regardless of the video's file size.
- If you use a slow writing memory card, the recording of your movie can be interrupted because the card cannot process data at the rate the video is being shot. If this occurs, replace the card with a faster memory card or reduce the video size (for example, from 1280X720 to 640X480).
- When recording a UHD video, we recommend you use a memory card with a write speed greater than 30 MB/sec.
- When you press the video recording button, intelli-zoom turns off.
- Videos can be darker than photos recorded at the same ISO sensitivity. If the videos appear darker, adjust the ISO sensitivity.
- When you record a video in P, A, or S mode, ISO is automatically set to **Auto**.
- Touching the screen to select a focus area while recording with Continuous AF switches the AF mode to Selection AF.



## 3D mode

You can capture 3D photos or videos with an optional 3D lens.

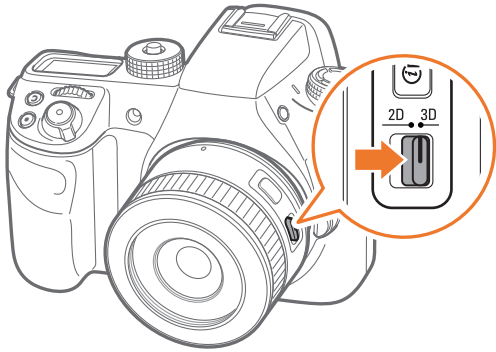

### SAMSUNG 45mm F1.8 [T6] 2D/3D lens (example)

Set the 2D/3D switch on the lens to **3D**, and then capture a photo or video 5 to 16.25 ft. (1.5–5 m) away from the subject.

- 3D mode is always on, regardless of the mode dial of the camera.
- To use auto 3D options that enable the camera to set shooting options automatically depending on shooting conditions in 3D mode, press [MENU] →  → **3D Auto Mode** → **On**.



- Available shooting options differ compared to other shooting modes.
- You can select either 5.9M (3232X1824) or 2.1M (1920X1080) photo size.
- The video resolution is set to 1920X1080.
- Videos recorded in 3D may be dark or playback may be jittery.
- Shooting in low temperatures may result in color distortion in images and may consume more battery power.
- You may not be able to shoot properly in conditions below 8.5 LV/900 lux. For best results, capture photos in places with sufficient light.
- When you photograph objects that contain polarizing material, such as a display, sunglasses, or a polarizing filter, or use polarizing material with your lens, the images may appear dark or the 3D effect may not be applied properly.
- Use a tripod to prevent your camera from shaking.
- If you rotate or tilt the camera vertically while shooting, the 3D effect may not be applied properly. Capture images with the camera in the normal position.
- If you shoot in fluorescent lighting or capture images displayed by projectors or TVs, the images may appear black due to the flicker effect.
- In 3D mode, the **Enlarge x8** option of **MF Assist** may not be available.
- The camera's display shows 3D videos only in 2D.
- Photos captured with the 3D function are saved in JPEG (2D) and MPO (3D) formats. On your camera's display, you can view only JPEG files.
- To view 3D files, connect your camera to a 3D TV or 3D monitor with an optional HDMI cable. While viewing, wear proper 3D glasses.
- You cannot use the flash in 3D mode.

## Available functions by shooting mode

For details about shooting functions, see Chapter 2.

You can press shortcut buttons to access selected functions as noted.

Function	Available in	Shortcut
Framing Mode (p. 126)	P/A/S/M	-
Photo Size (p. 89)	P/A/S/M/ <b>S</b> */ <b>AUTO</b> */ <b>3D</b> *	-
Quality (p. 90)	P/A/S/M/ <b>S</b> */ <b>AUTO</b> *	-
ISO (p. 91)	P/A/S/M	Fn/ISO
OLED Color (p. 93)	P/A/S/M/ <b>S</b> / <b>AUTO</b> / <b>3D</b>	-
White Balance (p. 94)	P/A/S/M/ <b>3D</b>	Fn/ <b>WB</b>
Picture Wizard (p. 96)	P/A/S/M/ <b>3D</b>	Fn
Smart Filter (p. 97)	P/A/S/M	-
AF Mode (p. 98)	P/A/S/M/ <b>S</b> */ <b>AUTO</b> / <b>3D</b> *	Fn
AF Area (p. 101)	P/A/S/M/ <b>S</b> *	Fn/ <b>AF</b>
Touch AF (p. 104)	P/A/S/M/ <b>S</b> */ <b>AUTO</b> */ <b>3D</b> *	-

Function	Available in	Shortcut
MF Assist (p. 106)	P/A/S/M/ <b>S</b> / <b>AUTO</b> / <b>3D</b> *	-
Focus Peaking (p. 108)	P/A/S/M/ <b>S</b> / <b>AUTO</b>	-
OIS (Anti-Shake) (p. 109)	P/A/S/M/ <b>S</b> */ <b>AUTO</b>	-
Drive (Single/Continuous/Timer/Bracketing) (p. 110)	P/A/S/M/ <b>S</b> */ <b>AUTO</b> */ <b>3D</b> *	Fn
Interval Capture (p. 115)	P/A/S/M	-
Flash (p. 116)	P*/A*/S*/M*/ <b>S</b> */ <b>AUTO</b> *	Fn
Metering (p. 122)	P/A/S/M	Fn/ 
Link AE to AF Point (p. 124)	P/A/S/M	-
Dynamic Range (p. 125)	P/A/S/M	-
Exposure compensation (p. 126)	P/A/S/M/ <b>S</b> */ <b>3D</b>	Fn
Exposure/Focus lock (p. 128)	P/A/S	<b>AEL</b>

\* Some functions are limited in these modes.



## Chapter 2

# Shooting Functions

---

Learn about the functions you can set in Shooting mode.  
You can enjoy more customized photos and videos by using the shooting functions.

# Size and Resolution

## Photo size













As you increase the resolution, your photo or video will include more pixels, so it can be printed on larger paper or displayed on a larger screen. When you use a high resolution, the file size will also increase. Select a low resolution for photos that will be displayed in a digital picture frame or uploaded to the web.



To set the size,

In Shooting mode, press [MENU] →  → **Photo Size** → an option.

\* Default

Icon	Size	Recommended for
	(3:2) 6480X4320*	Printing on A0 paper.
	(3:2) 4560X3040	Printing on A2 paper.
	(3:2) 3264X2176	Printing on A3 paper.
	(3:2) 2112X1408	Printing on A5 paper.
	(16:9) 6480X3648	Printing on A0 paper or viewing on an HDTV.
	(16:9) 4608X2592	Printing on A2 paper or viewing on an HDTV.
	(16:9) 3328X1872	Printing on A4 paper or viewing on an HDTV.
	(16:9) 2048X1152	Printing on A5 paper or viewing on an HDTV.
	(1:1) 4320X4320	Printing a square photo on A2 paper.
	(1:1) 3088X3088	Printing a square photo on A3 paper.
	(1:1) 2160X2160	Printing a square photo on A4 paper.
	(1:1) 1408X1408	Printing a square photo on A5 paper.



Available options may differ depending on shooting conditions.

## Quality

The camera saves photos in either the JPEG or RAW format.

Photos captured by a camera are often converted to the JPEG format and stored in the memory according to the settings of the camera at the time of shooting. RAW files are not converted to the JPEG format and are stored in the memory without any changes.

RAW files have the file extension “SRW”. To adjust and calibrate exposures, White Balances, tones, contrasts, and colors of the RAW files, or to convert them into JPEG or TIFF format, use the Adobe Photoshop Lightroom program found on the supplied DVD-ROM.







As RAW files are very large, ensure there is enough space on the memory card to save them in this format.

To set the quality,

In Shooting mode, press [MENU] →  → **Quality** → an option.

Icon	Format	Description
	JPEG	<p><b>Super Fine*</b>:</p> <ul style="list-style-type: none"> <li>Compressed for the best quality.</li> <li>Recommended for printing in large sizes.</li> </ul>

\* Default

Icon	Format	Description
	JPEG	<p><b>Fine:</b></p> <ul style="list-style-type: none"> <li>Compressed for better quality.</li> <li>Recommended for printing in normal sizes.</li> </ul>
	JPEG	<p><b>Normal:</b></p> <ul style="list-style-type: none"> <li>Compressed for normal quality.</li> <li>Recommended for printing in small sizes or for uploading to the web.</li> </ul>
	RAW	<p><b>RAW:</b></p> <ul style="list-style-type: none"> <li>Save a photo without data loss.</li> <li>Recommended for editing after shooting.</li> </ul>
	RAW+JPEG	<p><b>RAW + S.Fine:</b> Save a photo in both the JPEG (S.Fine quality) and RAW format.</p>
	RAW+JPEG	<p><b>RAW + Fine:</b> Save a photo in both the JPEG (Fine quality) and RAW format.</p>
	RAW+JPEG	<p><b>RAW + Normal:</b> Save a photo in both the JPEG (Normal quality) and RAW format.</p>

\* Default



Available options may differ depending on shooting conditions.

# ISO sensitivity

The ISO sensitivity value represents the sensitivity of a camera to light.

The larger the ISO value, the more sensitive the camera is to light. Consequently, by selecting a higher ISO sensitivity value, you can capture photos in dim or dark places at faster shutter speeds. However, this may increase electronic noise and result in a grainy photo.

To set ISO sensitivity,

In Shooting mode, press [ISO] → an option.

## Examples

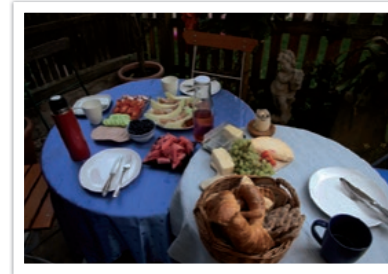

ISO 100



ISO 400



ISO 800



ISO 3200



- You can also set the option by pressing [MENU] →  → ISO → an option in Shooting mode.
- Increase the ISO value in places where flash use is prohibited. You can capture a clear photo by setting a high ISO value without having to secure more light.
- Use the Noise Reduction function to reduce the visual noise that can appear on photos taken at high ISO values. (p. 182)
- Available options may differ depending on the shooting conditions.
- You can set the ISO sensitivity up to ISO 6400 when recording a video.

## Customizing ISO settings

Set to adjust ISO Step, Auto ISO Range, or ISO Expansion.

To customize ISO settings,

In Shooting mode, press [MENU] →  → **ISO Customizing** → an option.

Option	Description
ISO Step	You can set the size of ISO sensitivity adjustments to either 1/3 step or 1 step.
Auto ISO Range	You can set the maximum ISO value under which each EV step is chosen when you set the ISO to Auto.
ISO Expansion	You can select ISO 51200.



You can select up to ISO 25600 when using **Continuous Normal**, or up to ISO 6400 when using **Continuous High**.



# OLED Color

Set the camera to optimize colors for playback on OLED displays. An OLED display has a wider color reproduction range than a liquid crystal display and produces brighter, natural colors.

To set OLED Color,

In Shooting mode, press [MENU] →  → **OLED Color** → an option.

## Examples



Without OLED Color effect



With OLED Color effect





# White Balance

The White Balance function adjusts the color in photos to give them a more natural appearance. You can use this function if color is affected by the type and quality of the light source. For example, fluorescent lamps can give colors in a photo a bluish hue. To offset this effect, select a White Balance option that adjusts the camera's settings for the light source. You can also adjust the White Balance by manually adjusting the camera's Color Temperature setting.

In addition, you can also customize the preset White Balance options so that the colors of the photo match the actual scene under mixed lighting conditions.







To set the White Balance,

In Shooting mode, press [WB] → an option.

Icon	Description
	<b>Auto WB*</b> : Automatically adjust the white balance settings for the light source.
	<b>Auto WB+Tungsten</b> : Automatically adjust the white balance settings for the light source except when shooting under incandescent or halogen lamps. This option does not offset the reddish hue of incandescent or tungsten bulbs.
	<b>Daylight</b> : Select when taking outdoor photos on a sunny day. This option results in photos closest to the natural colors of the scene.
	<b>Cloudy</b> : Select when taking outdoor photos on a cloudy day or in shadows. Photos captured on cloudy days tend to be more bluish than on sunny days. This option offsets that effect.

\* Default

\* Default

Icon	Description
	<b>Fluorescent White</b> : Select when shooting under a daylight fluorescent lamp, especially for white fluorescent light.
	<b>Fluorescent NW</b> : Select when shooting under a daylight fluorescent lamp, especially for white fluorescent light of very white hues.
	<b>Fluorescent Daylight</b> : Select when shooting under a daylight fluorescent lamp, especially for white fluorescent light of slightly bluish hue.
	<b>Tungsten</b> : Select when taking indoor photos under incandescent bulbs or halogen lamps. Incandescent tungsten bulbs tend to have a reddish hue. This option offsets that effect.
	<b>Flash WB</b> : Select when using a flash.
	<b>Custom Set</b> : Use your pre-defined settings. You can manually set the White Balance by pressing [DISP], and then shooting a white sheet of paper. Fill the spot metering circle with the paper and set the White Balance.
	<b>Color Temperature</b> : Manually adjust the color temperature of the light source. Color temperature is a measurement in degrees Kelvin that indicates the specific type of light source. You can get a warmer photo with a higher value, and a cooler photo with a lower value. Press [DISP], and then adjust the color temperature.



- You can also set the option by pressing [MENU] →  → **White Balance** → an option in Shooting mode.
- Available options may differ depending on shooting conditions.

### Customizing preset White Balance options

You can also customize preset White Balance options.

To customize  
preset options,

In Shooting mode, press [WB] → an option → [DISP] → scroll command dials 1 or 2 or rotate the navigation button or press [DISP/1/-/→].

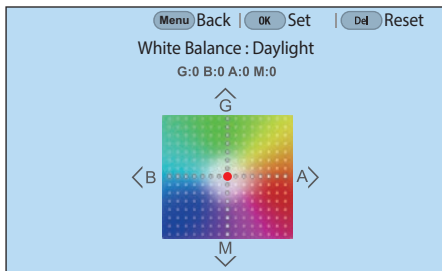

You can also touch an area on the screen.

### Examples



Auto WB



Daylight



Fluorescent Daylight

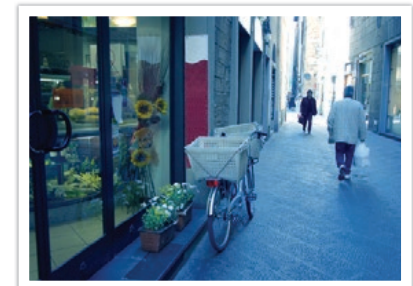

Tungsten



# Picture Wizard (photo styles)

Picture Wizard lets you apply different photo styles to your photo to create various looks and emotional moods. You can also create and save your own photo styles by adjusting color, saturation, sharpness, contrast, and hue for each style.

There is no rule that determines which style is suitable in which conditions. Experiment with different styles and find your own settings.

To set a photo style,

In Shooting mode, press [MENU] →  → **Picture Wizard** → an option.

## Examples



Standard

Classic

Vivid



Portrait

Landscape

Forest







Retro

Cool

Calm



- You can also adjust the value of the preset style settings. Select a Picture Wizard option, press [DISP], and then adjust color, saturation, sharpness, contrast, or hue.
- To customize your own picture wizard, select , , or  and then adjust the color, saturation, sharpness, and contrast.
- You can use  (Custom Pro) in C<sub>1</sub> and C<sub>2</sub> mode after you download the shooting settings (film) via a smart phone. (p. 78)
- Picture Wizard options cannot be set with Smart Filter options at the same time.

# Smart Filter

Smart Filter lets you apply special effects to your photos. You can select various filter options to create special effects that are difficult to achieve with normal lenses.

To set Smart Filter options,

In Shooting mode, press [MENU] →  → **Smart Filter** → an option.

\* Default

Option	Description
<b>Off*</b>	No effect
<b>Vignetting</b>	Apply the retro-looking colors, high contrast, and strong vignette effect of Lomo cameras.
<b>Miniature (H)</b>	Apply a tilt-shift effect to make the subject appear in miniature. The top and bottom of the photo will be blurred.
<b>Miniature (V)</b>	Apply a tilt-shift effect to make the subject appear in miniature. The left and right of the photo will be blurred.
<b>Watercolor</b>	Apply a watercolor painting effect.
<b>Red</b>	Desaturate all colors but red.
<b>Green</b>	Desaturate all colors but green.

\* Default

Option	Description
<b>Blue</b>	Desaturate all colors but blue.
<b>Yellow</b>	Desaturate all colors but yellow.



- You cannot set Smart Filter options and Picture Wizard options at the same time.
- Available options may differ depending on the shooting conditions.

# AF mode

Learn how to adjust the camera's focus according to the subjects.

You can select the appropriate focus mode for the subject: Single Auto Focus, Continuous Auto Focus, Active Auto Focus, or Manual Focus. The AF function is activated when you press **[Shutter]** halfway. In the MF mode, you have to rotate the focus ring on the lens to focus manually.

In most cases, you can make the camera focus by selecting **Single AF**. Fast moving subjects or subjects with small shading differences in the background are difficult to focus. Select an appropriate focusing mode for such instances.

If your lens has an AF/MF switch, you must set the switch according to the selected mode. Set the switch to AF when you select Single AF, Continuous AF, or Active AF. Set the switch to MF when you select Manual Focus.

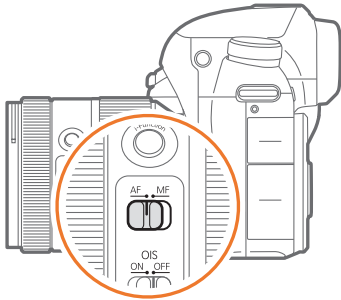

When your lens has no AF/MF switch, press **[AF]** to select a desired AF mode.

To set the auto focus mode,

In Shooting mode, press **[AF]** → an option.



- You can also set the option by pressing **[MENU]** →  → **AF Mode** → an option in Shooting mode.
- The available options may differ depending on the lens in use.

## Single AF

Single AF is appropriate for shooting a still subject. When you press **[Shutter]** halfway, the focus fixes in the focus area. The area turns green when the focus is achieved.



## Continuous AF

While you press **[Shutter]** halfway, the camera continues to focus automatically. This mode is recommended for shooting action.



- Depending on the type of lens, auto focus results may differ when you continuously capture photos using Continuous AF. Use an optional lens for smooth auto focus operation. Select an optional lenses from the following:
  - SAMSUNG 16-50mm F2-2.8 S ED OIS
  - SAMSUNG 16-50mm F3.5-5.6 Power Zoom ED OIS
  - NX 50-150mm F2.8 S ED OIS
- When using **Continuous AF** and **Multi AF**, press **[AF-ON]** to resize or move the focus area while shooting. Use the navigation button or command dial 2 to move the focus area. Scroll command dial 1 to resize the focus area. When you press **[Shutter]** halfway, the camera focuses only on the set focus area. The focus area moves with the subject after the focus is set correctly.

## Active AF

While you are pressing [**Shutter**] halfway, the camera automatically detects the subject's movements and switches between Single AF and Continuous AF. It fixes the focus on the subject when the subject gets far from the camera (Single AF). It continues to focus automatically when the subject gets closer to the camera (Continuous AF). This mode is recommended for shooting subjects that are moving unpredictably.

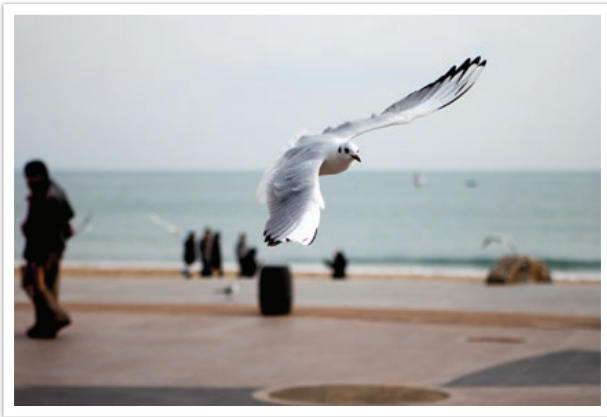

This option is not available when recording a video.

## Manual focus

You can manually focus on a subject by rotating the focus ring on the lens. The MF Assist function lets you easily bring a subject into focus. While you are rotating the focus ring, the focus area is magnified. When you use the Focus Peaking function, the color you selected appears on the focused subject. This mode is recommended for shooting a subject similar in color to the background, a night scene, or fireworks.



If you use this function, you cannot set **Touch AF**, **AF Area**, and **Link AE to AF Point** options.

# AF area

The AF area function changes the positions of the focus area.

Generally, cameras focus on the nearest subject. When there are multiple subjects, however, unwanted subjects can be in focus. To prevent unwanted subjects from being in focus, change the focus area so that a desired subject is in focus. You can get a clearer and sharper photo by selecting an appropriate focus area.

To set the auto focus area,

In Shooting mode, press [MENU] →  → **AF Area** → an option.





- Available options may differ depending on shooting conditions.
- When the AF/MF switch is set to **MF**, you cannot change the AF area from the shooting menu.
- When you use the Face Detection AF option, the camera focuses on the area with the white frame automatically.
- Depending on the Picture Wizard options, Face Detection may not be effective.
- When you set manual focus, Face Detection may not be available.
- Face Detection may not be effective when:
  - The subject is far from the camera.
  - It is too bright or too dark.
  - The subject is not facing the camera.
  - The subject is wearing sunglasses or a mask.
  - The subject's facial expression changes drastically.
  - The subject is backlit or the lighting conditions are unstable.

## Selection AF

You can set the focus on an area you want. Apply an out-of-focus effect to make the subject more distinguishable.

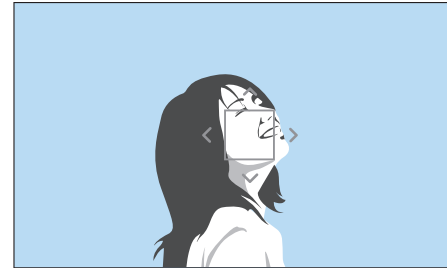
The focus on the photo below was repositioned and resized so that it fits the subject's face.



To resize or move the focus area, in Shooting mode, press []. Use the navigation button or command dial 2 to move the focus area. Scroll command dial 1 to resize the focus area.

### Saving Selection AF position

You can set the camera to remember the most recent AF position used by Selection AF and Touch AF before turning the camera off.

To set this function,

In Shooting mode, press [MENU] →  → **Save Selection AF Position** → an option.

### Multi AF

The camera displays a green rectangle in places where focus is set correctly. The photo is divided into two or more areas, and the camera obtains focus points of each area. This mode is recommended for taking photos of scenery.

When you press [**Shutter**] halfway, the camera displays the focus areas as shown in the photo below.

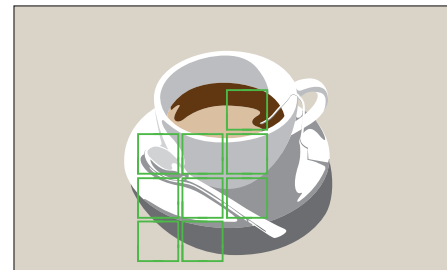

## Face Detection AF

The camera focuses on human faces preferentially. Faces of up to 10 people can be detected. This setting is recommended for shooting a group of people.

When you press [**Shutter**] halfway, the camera focuses on faces as shown in the photo below. In cases of shooting a group of people, the camera displays the focus on the nearest person's face or on the face in the center of the screen in white and the rest of the people's faces in gray.

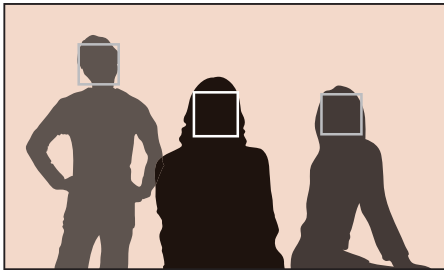

## Self-Portrait AF

It can be difficult to check whether your face is in focus when you are taking a self-portrait. When this function is on, the camera beeps faster when your face is in focus and located at the center of the composition.





# Touch AF

Select or focus on an area that you touch on the screen. Additionally, focus on the subject and capture a photo by touching the screen.

To set Touch AF,

In Shooting mode, press [MENU] →  → **Touch AF** → an option.



Available options may differ depending on the shooting conditions.

## Touch AF

Touch AF allows you to select and focus on the focus area that you touch on the screen.

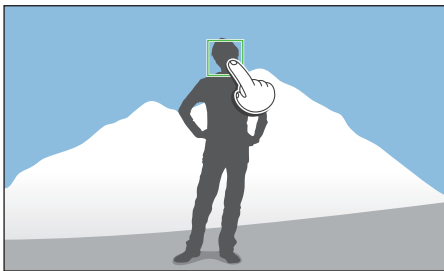

## AF Point

The focus area will correspond to the area you touch on the screen and the focus will not be achieved.

## Tracking AF

Tracking AF allows you to track and automatically focus on your subject, even when the subject is moving or when you change the shooting composition.

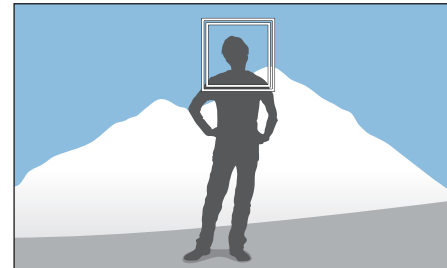

**White frame:** Your camera is tracking the subject.

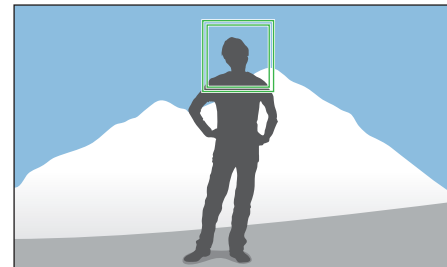

**Green frame:** Your subject is in focus when you half-press [Shutter].

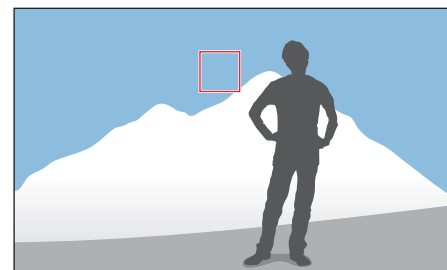

**Red frame:** Your camera failed to focus.



- If you do not select a focus area, the Auto Focus function does not work.
- Tracking a subject may fail when:
  - The subject is too small.
  - The subject moves irregularly.
  - The subject is backlit or you are shooting in a dark place.
  - Colors or patterns on the subject and the background are the same.
  - The subject includes horizontal patterns, such as blinds.
  - The camera shakes excessively.
  - You capture photos continuously.
- When tracking fails, the feature will be reset.
- If the camera fails to track the subject, the focus area will be reset.
- If the camera fails to focus, the focus frame will change to red and the focus will be reset.
- When you select Tracking AF, the AF mode is set to Continuous AF.

## One touch shot

You can capture a photo with the touch of your finger. As you touch a subject, the camera focuses on the subject automatically and captures a photo.

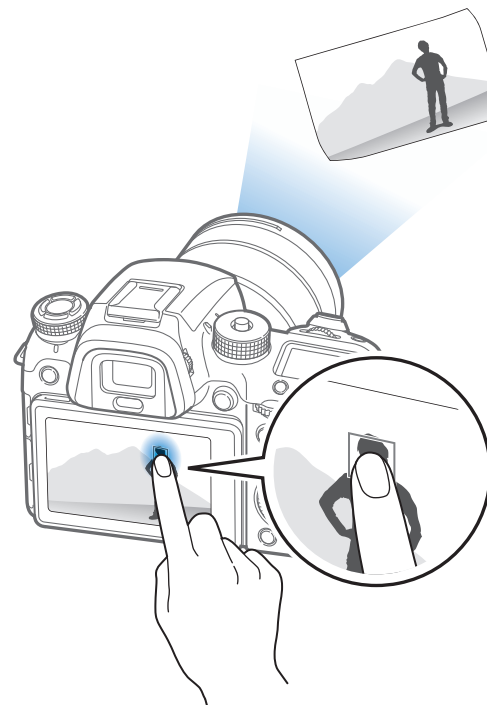

# Focus assist

Use various focus assist functions while focusing the camera automatically or manually. Manual focus assist functions are available only with lenses that support manual focus.



## MF Assist

In the manual focus mode, you can enlarge the scene and easily adjust the focus while rotating the focus ring.

To set the manual focus assist,

In Shooting mode, press [MENU] →  → **MF Assist** → an option.

\* Default

Option	Description
<b>Off</b>	Do not use the MF Assist function.
<b>Enlarge x5*</b>	<p>The focus area is magnified by 5 times when you rotate the focus ring.</p> 
<b>Enlarge x8</b>	<p>The focus area is magnified by 8 times when you rotate the focus ring.</p> 

## DMF (Direct Manual Focus)

You can adjust the focus manually by rotating the focus ring after achieving focus by half-pressing [**Shutter**].

To set the DMF function,

In Shooting mode, press [MENU] →  → **DMF** → an option.

### Setting DMF responsiveness

Set the focus ring's response when you use the DMF function. If you select **High**, slight rotations of the focus ring will adjust the focus. If you select **Low**, longer rotations of the focus ring will adjust the focus.

To set DMF Responsiveness options,

In Shooting mode, press [MENU] →  → **DMF Responsiveness** → an option.

## AF Release Priority

Set to capture a photo when focus is achieved, or to select accuracy priority or shooting speed priority.

To set AF Release Priority options,

In Shooting mode, press [MENU] →  → **AF Release Priority** → an option.

\* Default

Option	Description
Focus*	<p>Capture a photo only when the focus is achieved. You can set the priority either on focus accuracy or shooting speed.</p> <ul style="list-style-type: none"> <li>• <b>Auto*</b>: The camera automatically selects Accuracy priority or Shooting speed priority.</li> <li>• <b>Accuracy priority</b>: Sets accurate focus as the priority. When you select the <b>Continuous High</b> shooting method, the Accuracy priority setting is applied only on the first shot.</li> <li>• <b>Shooting speed priority</b>: Sets the shooting speed as the priority.</li> </ul>
Release	<p>Capture a photo when you press [<b>Shutter</b>] even when focus is not achieved.</p>

## Focus Peaking

In the manual focus mode, the color you selected appears on the focused subject to help you focus while rotating the focus ring.

To set Focus Peaking options,

In Shooting mode, press [MENU] →  → **Focus Peaking** → an option.

\* Default

Option	Description
Level	Set a sensitivity for detecting the focused subject. (Off, High, Normal*, Low)
Color	Set a color to appear on the focused subject. (White*, Red, Green)



# Optical Image Stabilization (OIS)

Use the Optical Image Stabilization (OIS) function to minimize camera shake. OIS may not be available with some lenses.



Camera shake tends to occur in dark locations or when shooting indoors. Under these conditions, the camera uses slower shutter speeds to increase the amount of light it takes in, which can result in a blurry photo. You can prevent this by using the OIS function.

If your lens has an OIS switch, you must set the switch to **ON** to use the OIS function.

To set OIS options,

In Shooting mode, press [MENU] →  → **OIS (Anti-Shake)** → an option.

\* Default

Icon	Description
	<b>Off:</b> The OIS function is off.
	<b>Mode 1*:</b> The OIS function is applied only when you full or half press [Shutter].
	<b>Mode 2:</b> The OIS function is on.

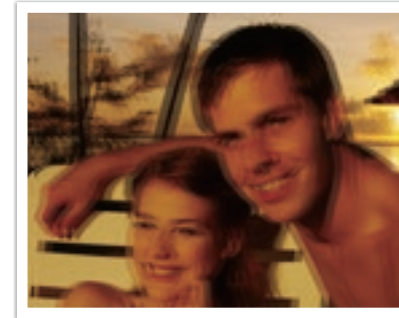

Without OIS correction

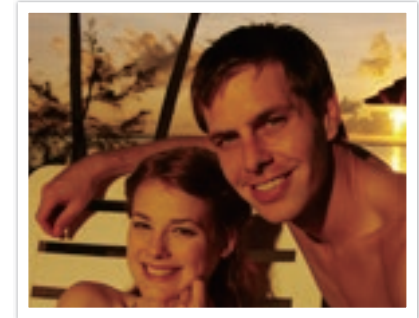

With OIS correction



- OIS may not function properly when:
  - You move your camera to follow a moving subject.
  - There is too much camera shake.
  - The shutter speed is slow (for example, when you select **Night** in **S** mode).
  - The battery is low.
  - You capture a close-up shot.
- If you use the OIS function with a tripod, your images may be blurred by the vibration of the OIS sensor. Deactivate the OIS function when you use a tripod.
- If the camera is hit or dropped, the display will be blurry. If this occurs, turn off the camera, and then turn it on again.
- Use the OIS function only when needed because the function consumes more battery power.
- To set an OIS option on the menu, set the OIS switch on your lens to **ON**.
- This option may not be available with some lenses.

# Drive (shooting method)

You can set the shooting method, such as Continuous, Timer, or Bracketing.

Select **Single** to capture one photo at a time. Select **Continuous Normal** or **Continuous High** to shoot fast moving subjects. Select **AE Bracket**, **WB Bracket**, **P Wiz Bracket**, or **Depth Bracket** to adjust exposure, White Balance, apply picture Wizard effects, or capture photos with different depths of field. You can also select **Timer** to capture a photo automatically after a specified time.



Available options may differ depending on shooting conditions.

Rotate the drive dial to select a shooting method.

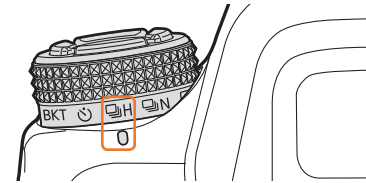

When Continuous High is selected (example)

Icon	Description
	Single (p. 111)
	Continuous Normal (p. 111)
	Continuous High (p. 111)
	Timer (p. 112)
	Bracketing (p. 112)



Do not rotate the drive dial beyond the permitted limits. Doing so may damage the camera.

## Single

Capture one photo whenever you press **[Shutter]**. Recommended for general conditions.

To set the shooting method,



Rotate the drive dial to .





## Continuous

Continuously capture photos while you are pressing **[Shutter]**. If you selected **Continuous High**, you can capture up to 8, 10, 12, or 15 photos per second.

To set the shooting method,

Rotate the drive dial to N (Continuous Normal) or H (Continuous High).



- To set the shooting speed, rotate the drive dial to H, and then press [MENU] →  → **Drive Settings** → **Continuous High** → set the shooting speed.
- The noise reduction function is not available when **Continuous High** is selected.
- The Tracking AF function is available with this option.
- You can select up to ISO 25600 when using **Continuous Normal**, or up to ISO 6400 when using **Continuous High**.
- When you continuously capture photos, for best results set the shutter speed at 1/250 s or higher. If you set the shooting speed at 15 fps in **Continuous High**, set the shutter speed at 1/500 s or higher.





## Timer

Capture a photo after a specified time. You can also set the shooting interval, number of shots, and shooting time.

To set the shooting method,

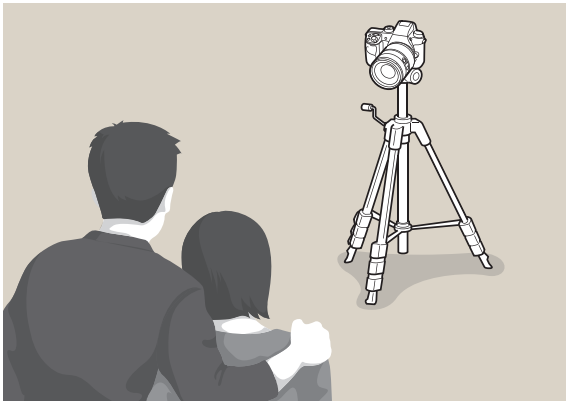
Rotate the drive dial to .



- Press **[Shutter]** to stop capturing.
- To set the timer details, rotate the drive dial to , and then press **[MENU]** →  → **Drive Settings** → **Timer** → set the shooting interval, number of shots, and shooting time.

## Auto Exposure Bracketing (AE Bracket)

When you press **[Shutter]**, the camera captures 5 consecutive photos: the original and four more with different exposure settings. Use a tripod to prevent blurry photos as the camera captures five photos continuously. You can adjust the settings in the Bracket Settings menu.

To set the shooting method,

Rotate the drive dial to **BKT**, and then press **[MENU]** →  → **Drive Settings** → **Bracket** → **AE Bracket**.

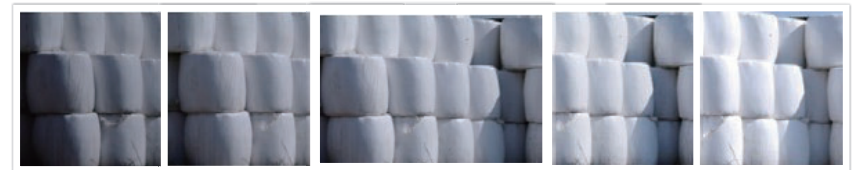

Darker ← Original → Brighter

## White Balance Bracketing (WB Bracket)

When you press [**Shutter**], the camera captures 3 consecutive photos: the original and two more with different White Balance settings. The original photo is captured when you press [**Shutter**]. The other two are automatically adjusted according to the White Balance you have set. You can adjust the settings in the Bracket Settings menu.

To set the shooting method,

Rotate the drive dial to BKT, and then press [MENU] →  → **Drive Settings** → **Bracket** → **WB Bracket**.



MG-2



Original



MG+2



This option cannot be used with the RAW file format. Selecting this option will change the photo quality from RAW to JPEG.

## Picture Wizard Bracketing (P Wiz Bracket)

When you press [**Shutter**], the camera captures 3 consecutive photos, each with a different Picture Wizard setting. The camera captures a photo and applies the three Picture Wizard options you have set to the image captured. You can select three different settings in the Bracket Settings menu.

To set the shooting method,

Rotate the drive dial to BKT, and then press [MENU] →  → **Drive Settings** → **Bracket** → **P Wiz Bracket**.



Vivid



Standard



Retro



This option cannot be used with the RAW file format. Selecting this option will change the photo quality from RAW to JPEG.

## Depth Bracketing

When you press [**Shutter**], the camera captures 3 consecutive photos, each with a different depth of field by adjusting the aperture value. Use a tripod to prevent blurry photos as the camera captures three photos continuously. You can adjust the settings in the Bracket Settings menu.

To set the shooting method,

Rotate the drive dial to BKT, and then press [MENU] →  → **Drive Settings** → **Bracket** → **Depth Bracket**.



This feature is available only in Program or Aperture priority mode.

### Bracketing settings

You can set up the options for each bracket function.

To set a bracketing option,

In Shooting mode, press [MENU] →  → **Drive Settings** → **Bracket** → scroll to an option, and then press [←] (right) → set up the options for each bracketing.

\* Default

Option	Description
<b>AE Bracket</b>	Set the exposure interval. (-/+ <b>0.3 EV*</b> , -/+ <b>0.7 EV</b> , -/+ <b>1.0 EV</b> , -/+ <b>1.3 EV</b> , -/+ <b>1.7 EV</b> , -/+ <b>2.0 EV</b> , -/+ <b>2.3 EV</b> , -/+ <b>2.7 EV</b> , -/+ <b>3.0 EV</b> )
<b>WB Bracket</b>	Adjust the White Balance interval range of the 3 bracketed photos. ( <b>AB -/+1</b> , <b>AB -/+2</b> , <b>AB -/+3*</b> , <b>MG -/+1</b> , <b>MG -/+2</b> , <b>MG -/+3</b> ) For example, AB -/+3 adjusts the Amber value plus or minus three steps. MG -/+3 adjusts the Magenta value the same amount.
<b>P Wiz Bracket</b>	Select the 3 Picture Wizard settings the camera will use to capture the 3 bracketed photos.
<b>Depth Bracket</b>	Set the depth interval. Use command dials 1 or 2 or the navigation button to select an option. You can also drag the slider or touch the arrows to select an option. (-/+ <b>0.3</b> , -/+ <b>0.7</b> , -/+ <b>1.0*</b> , -/+ <b>1.3</b> , -/+ <b>1.7</b> , -/+ <b>2.0</b> , -/+ <b>2.3</b> , -/+ <b>2.7</b> , -/+ <b>3.0</b> )



# Interval Capture

Set the shooting interval, the number of shots, and shooting start time. Use this function to capture photos at regular intervals during an event, such as a lunar eclipse or a sunrise.

To capture an interval shot,

In Shooting mode, press [MENU] →  → **Interval Capture** → set a shooting interval, the number of shots, and shooting start time → **Start Interval Capture** → wait for shooting to begin at the time you set. (If you did not set a shooting start time, press [**Shutter**] to capture the photo.)









- To save interval shots as a video, select **Time Lapse** → **On**. The camera records a UHD video up to 60 seconds long at a rate of 10 fps. When using the Time Lapse function, you can set the count to less than 600 shots.
- If you set the interval count to more than 600 shots or there is not enough space on the memory card after the Time Lapse function has been set, the interval count will change automatically to allow you to use the Time Lapse function.
- If you set the interval time to 1 second and set the Time Lapse function, the interval time will change to 2 seconds.
- Touch  to pause while capturing photos.
- Touch  to resume.
- Touch  or press [MENU] to stop capturing.
- Use a shutter release cable with a tripod to minimize camera movement when capturing interval shots.
- Connect the power cable if the shooting interval is long or the number of shots to be taken is high.
- If the shooting interval is set to between one minute and 10 minutes, the camera will enter Display save mode after it starts to capture a photo. If a shooting interval exceeds 10 minutes, the camera will enter Power save mode and turn on and capture a photo automatically at the next interval. Press [**Shutter**] to cancel Power save mode.
- If the battery or memory card is removed while capturing photos, shooting will stop. Before removing the battery or memory card, interval shooting must be paused and the camera must be turned off.

## Flash



In order to capture a realistic photo of a subject, the amount of light should be constant. When the light source varies, you can use a flash and supply a constant amount of light. Select appropriate settings according to a light source and a subject.

To set flash options,

In Shooting mode, press [MENU] →  → **Flash** → an option.

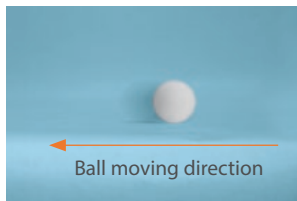
Icon	Description
	<b>Off:</b> The flash is off.
	<b>Smart Flash:</b> The camera automatically adjusts the brightness of the flash according to the amount of light in the surrounding environment.
	<b>Auto:</b> The flash automatically fires in dark locations.
	<b>Auto Red-eye:</b> The flash automatically fires and reduces red-eye.
	<b>Fill in:</b> The flash fires whenever you capture a photo. (Brightness is automatically adjusted.)
	<b>Fill-in Red:</b> The flash fires whenever you capture a photo and reduces red-eye.
	<b>1st Curtain:</b> The flash fires immediately after the shutter opens. The camera captures a photo of a subject earlier in an action sequence clearly.



Icon	Description
	<b>2nd Curtain:</b> The flash fires just before the shutter closes. The camera captures a photo of a subject later in an action sequence clearly.
	<b>Hi-speed:</b> If the shutter speed is faster than the camera's sync speed (the quickest time taken to open and close the shutter), the flash will fire multiple times at high speed. The flash starts to fire while the shutter opens. This option can be set only when you attach a compatible, optional external flash. (SEF-580A)

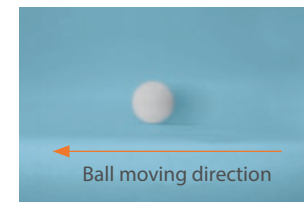

- The available options may differ depending on shooting conditions.
- There is an interval between two bursts of the flash. Do not move until the flash fires a second time.
- If you select **Off**, the flash does not fire even when an external flash is attached. If you adjust the flash intensity manually, the flash will fire once without a pre-flash.



Use only Samsung-approved flashes. Using incompatible flashes may damage your camera.

## Reducing the red-eye effect

If the flash fires when you capture a photo of a person in the dark, a red glow may appear in their eyes. To reduce the red-eye effect, select **Auto Red-eye** or **Fill-in Red**.



Without red-eye reduction



With red-eye reduction



When the red-eye reduction function is used, there are two separate flashes. The subject should not move until after the second flash. If the subject is too far from the camera or moves after the first flash fires, red-eye may not be reduced.

## Using the built-in flash

To open the built-in flash, press the flash pop-up button. The flash does not fire when the built-in flash is closed.

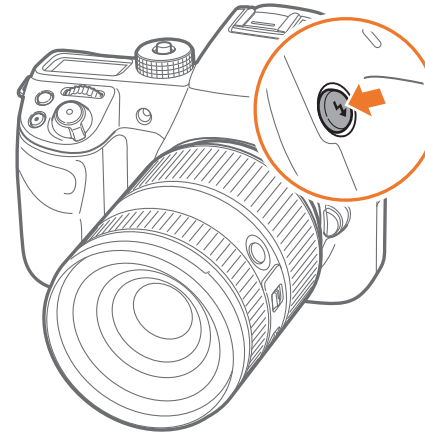



## Adjusting the flash intensity

When the flash is on, adjust the flash intensity +/-2 levels.

To set the flash intensity,

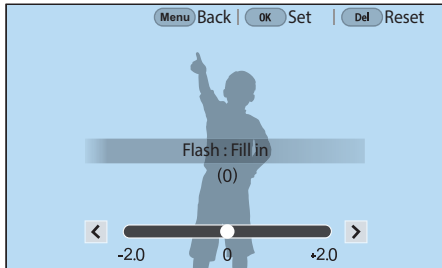
In Shooting mode, select [MENU] →  → **Flash** → an option → [DISP] → scroll command dial 1 or command dial 2 or rotate the navigation button or press [←/→] to adjust the flash intensity.



- You can also drag the slider or touch   to adjust the intensity.
- Adjusting the flash intensity may not be effective when:
  - The subject is too close to the camera.
  - You set a high ISO sensitivity.
  - The exposure value is too big or too small.
  - It is too bright or too dark.
- In some shooting modes, you cannot use this function.
- If you attach an intensity-adjustable external flash to the camera, the intensity settings of the flash will be applied.
- If the subject is too close when you use the flash, some light may be blocked, resulting in a dark photo. Ensure that the subject is within the recommended range, which varies by lens.
- When a lens hood is attached, the light from the flash can be blocked by the hood. Remove the hood to use the flash.

## Flash settings

Set the flash mode, exposure value, flash brightness, or multi flash when you attach an external flash to the camera. You can also set wireless sync to control the internal or external flash. The flash settings are supported only when you attach a compatible, optional external flash (SEF-580A).

### Setting external flash

To set external flash,

In Shooting mode, press [MENU] →  → **External Flash Settings** → an option.

Option	Description
Flash Mode	<ul style="list-style-type: none"> <li>• <b>A-TTL:</b> In the A-TTL (Advanced Through The Lens) mode, the camera measures the light reflected by the subject through the lens. Then, it calculates the optimum exposure based on the exposure value and shutter speed.</li> <li>• <b>Manual Flash:</b> The flash emits the full amount of light or the flash intensity can be adjusted manually.</li> <li>• <b>Multi Flash:</b> When you press [<b>Shutter</b>], the flash fires multiple times based on the number you have set.</li> </ul>
Flash EV	Set the exposure of the flash when the flash mode is <b>A-TTL</b> .
Flash Output	Set the brightness of the flash when the flash mode is <b>Manual Flash</b> .
Multi Flash Settings	Set the count, brightness, or frequency of the flash when the flash mode is <b>Multi Flash</b> .



If data can be exchanged between the camera and the flash, the settings for the external flash can be adjusted on the camera or the flash. Your previous options will be applied.



### Setting wireless sync for internal or external flash

Set wireless sync to control internal and external flash units remotely via wireless signals. The remote system consists of a master flash that is mounted on the camera and one or more slave flash units. A slave flash is assigned to one of three groups: A, B, or C.

To set wireless sync,

In Shooting mode, press [MENU] →  → **Internal Wireless Flash** or **External Wireless Flash** → an option.

Option	Description	* Default
<b>Use Wireless Flash</b>	Set to use wireless sync. ( <b>Off*</b> , <b>On</b> )	
<b>Channel</b>	Select channels for wireless sync. There are four remote channels available to allow multiple remote systems to operate at the same time. Master and slave flash units, in the same remote system, must be set to the same channel. ( <b>Ch. 1</b> , <b>Ch. 2</b> , <b>Ch. 3</b> , <b>Ch. 4</b> )	
<b>Group Flash Mode</b>	Set the flash mode for group A, B, or C. Changes to the flash mode must be made on the master flash. The changes are then applied to slave group A, B, or C, and the slave groups operate as a remote system of the flash mode (TTL or manual) according to the settings for the master flash. <ul style="list-style-type: none"> <li>• <b>A-TTL</b>: Set the exposure of the flash when the flash mode is <b>A-TTL</b>.</li> <li>• <b>Manual Flash</b>: Set the brightness of the flash when the flash mode is <b>Manual Flash</b>.</li> <li>• <b>Off</b>: Do not fire the flash.</li> </ul>	



- You cannot select **External Flash Settings** when you use the External Wireless Flash function.
- For information about using the wireless sync feature with an external flash, refer to the optional external flash's (SEF-580A) user manual.

## Locking the flash intensity

When the flash mode is set to A-TTL, the camera automatically calculates the optimum exposure through pre-flash. If the exposure is not calculated correctly, use the FEL function. The pre-flash fires on the area that you set and the flash intensity is locked.

To lock the flash intensity,

Set the function of [AEL] to **FEL** → focus on the exposure area → press [AEL].



# Metering

The metering mode refers to the way in which a camera measures the quantity of light.

The camera measures the amount of light in a scene, and in many of its modes, uses the measurement to adjust various settings. For example, if a subject looks darker than its actual color, the camera captures an overexposed photo of it. If a subject looks lighter than its actual color, the camera captures an underexposed photo of it.

The brightness and overall mood of the photo can also be affected by how the camera measures the amount of light. Select an appropriate setting for a shooting condition.

To set a metering option,

In Shooting mode, press [  ] → an option.

## Multi

The Multi mode calculates the amount of light in multiple areas. When light is sufficient or insufficient, the camera adjusts the exposure by averaging the overall brightness of the scene. This mode is suitable for general photos.



## Center-weighted

The Center-weighted mode calculates a broader area than the Spot mode does. It sums up the amount of light in the center portion of the shot (60–80 %) and that of the rest of the shot (20–40 %). It is recommended for situations where there is a slight difference in brightness between a subject and its background or where the area around a subject is large compared to the overall composition of the photo.



## Spot

The Spot mode calculates the amount of light in the center. When you capture a photo in conditions where there is a strong backlight behind a subject, the camera adjusts the exposure to shoot the subject correctly. For example, when you select the Multi mode in a strong backlight condition, the camera calculates that the overall amount of light is abundant, which results in a darker photo. The Spot mode can prevent this situation as it calculates the amount of light in a designated area.

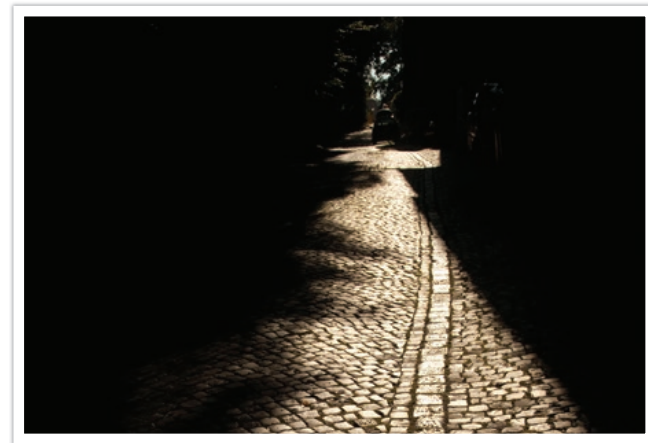

As the photo illustrates, the subject is in a bright area while the background is dark. The Spot mode is recommended for a situation like this where there is a large difference in the exposure values between the subject and the background.

### Measuring the exposure value of the focus area

When this function is turned on, the camera automatically sets an optimal exposure by calculating the brightness of the focus area. This function is only available when you select **Spot** metering or **Multi** metering, and **Selection AF**.

To set this function,

In Shooting mode, press [MENU] →  → **Link AE to AF Point** → an option.



# Dynamic Range

This function automatically corrects the loss of bright detail that can occur due to shading differences in the photo.

To set Dynamic Range options,

In Shooting mode, press [MENU] →  → **Dynamic Range** → an option.





Without Dynamic Range effect



With Dynamic Range effect

\* Default

Icon	Description
	<b>Off*</b> : Dynamic Range is off.
	<b>Smart Range+</b> : Corrects for the loss of bright detail.
	<p><b>HDR</b>: Capture several photos with different exposures, and then combine them to automatically create a single image.</p> <ul style="list-style-type: none"> <li>To set the exposure adjustment value, press [−] (right), and then select <b>Low</b>, <b>Medium</b>, or <b>High</b>.</li> <li>You cannot set an ISO option higher than ISO 6400.</li> <li>Dynamic Range options and Picture Wizard options cannot be set at the same time.</li> </ul>

# Exposure compensation

The camera automatically sets the exposure by measuring the levels of light from the photo's composition and the position of a subject. If the exposure set by the camera is higher or lower than you expected, you can adjust the exposure value manually. The exposure value is adjustable in  $\pm 5$  increments. The camera displays the exposure warning in red for each step beyond  $\pm 5$  range. When recording a video, the exposure value is adjustable in  $\pm 3$  increments.

To adjust the exposure value, while holding down [Fn], scroll command dial 2. You can also adjust the exposure value by pressing [Fn], and then selecting **EV**.

When you compensate the exposure value in Manual mode, the current shutter speed and aperture value do not change. When you adjust the exposure value by rotating command dial 2 while holding down [Fn] when ISO sensitivity is set to Auto, the exposure value adjusts by changing the ISO sensitivity.

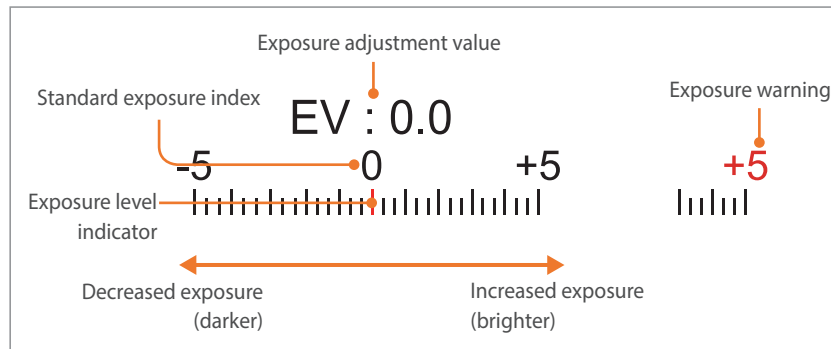

## Using Framing Mode

When you adjust the aperture value or shutter speed, the exposure changes according to the settings, so the display may darken. With this function on, the brightness of the display is constant regardless of the settings, so you can better frame your shot.

To use **Framing Mode**,

In Shooting mode, press [MENU] → [Camera icon] → **Framing Mode** → an option.

### Viewing the overexposure guide

View overexposed areas on a photo in Shooting mode before capturing a photo. Setting this feature will cause the overexposed areas of a photo to blink.



To view the overexposure guide,

In Shooting mode, press [MENU] →  → **Overexposure Guide** → an option.

### Using the brightness adjustment guide

Adjust the brightness using the selected area as a reference. The brightness of the selected area is displayed as a value to help you to conveniently adjust the brightness.

To adjust the brightness,

In Shooting mode, press [MENU] →  → **Brightness Adjustment Guide** → **On** → locate  on the screen in the reference area → press [AEL] → use command dials 1 and 2, or the navigation button, or drag the slider to adjust the brightness.



- This feature is available only in Program, Aperture Priority, or Shutter Priority mode.
- This feature and the overexposure guide cannot be set at the same time.
- This feature and the Dynamic Range HDR option cannot be set at the same time.
- This feature and the flash options cannot be set at the same time.

### Histogram

Set the histogram on the display on or off.

### About histogram

A histogram is a graph that shows the brightness distribution of a photo. A histogram inclined to the left indicates a dark photo. A histogram inclined to the right indicates a bright photo. The height of the graph is related to color information. The graph gets higher if a specific color is more common.



Insufficient exposure

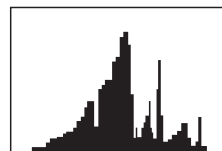

Balanced exposure



Excessive exposure



# Exposure/Focus lock

If you cannot achieve an appropriate exposure because of a strong light/dark contrast between the subject and the background, or you want to capture a photo in which the subject is out of the auto focus area, lock the focus or exposure and then capture a photo.

When the exposure lock function is assigned to [AEL] (Example)

- 1 Set the focus frame and half-press [**Shutter**] to measure the exposure.

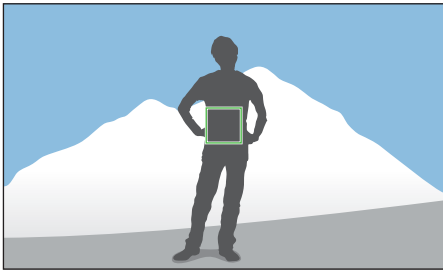

- 2 Press [**AEL**] to lock the exposure.
- 3 Make changes to the composition after the exposure is locked.

- 4 Half-press [**Shutter**] to achieve the focus, and then press [**Shutter**] to take a photo.

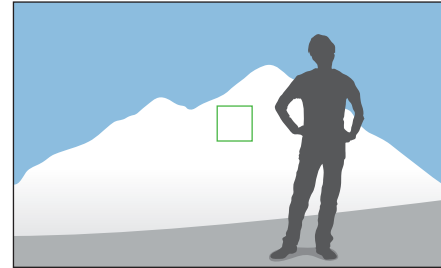

When the focus lock function is assigned to [AEL] (Example)

- 1 Set the focus frame and half-press [**Shutter**] to achieve the focus.
- 2 Press [**AEL**] to lock the focus.
- 3 Make changes to the composition after the focus is locked.
- 4 Half-press [**Shutter**] to measure the exposure, and then press [**Shutter**] to take a photo.



You can change the function assigned to [AEL] to focus lock, exposure lock, or both. (p. 185)

# Exposure/Focus separation

Separate the exposure area and the focus area or merge them again. This feature is available only when Touch AF is set to **Touch AF**.

1 On the screen, touch an area to focus on it.

- The exposure separation icon  will appear on the focus frame.

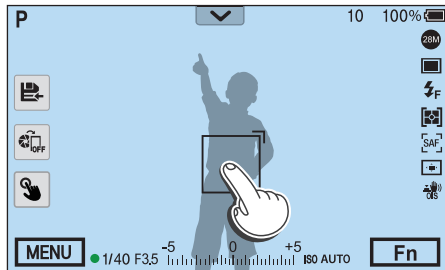

2 Drag  to the exposure area.

- The focus area and the exposure area will be separated.
- Touch and hold each area to lock the focus or exposure setting.
- Drag the areas together to merge the focus area and the exposure area.

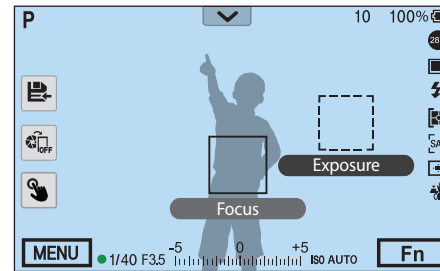

3 Press [**Shutter**] to capture the photo.

- The focus area and the exposure area will return to their pre-shooting position.



- If you press [**AEL**] while its function is set to **AEL Hold**, the exposure/focus will not be separated.
- You can set to use the Exposure/Focus Separation function by pressing [MENU] →  → **Exposure/Focus Separation** → **Off** or **On** in Shooting mode.

# Video functions

The functions available for video are explained below.

## Movie size















Set the movie size.

To set movie size options,

In Shooting mode, press [MENU] →  → **Movie Size** → an option.













### When Video Out is set to NTSC

\* Default

Icon	Size	Recommended for
	4096X2160 (24p)	View on a 4K UHD TV.
	3840X2160 (30p)	View on a 4K UHD TV.
	3840X2160 (24p)	View on a 4K UHD TV.
	3840X2160 (23.98p)	View on a 4K UHD TV.
 *	1920X1080 (60p)	View on a Full HDTV. (Videos recorded with this option may not play on some HDTVs or smart phones that do not support 60p.)
	1920X1080 (30p)	View on a Full HDTV.
	1920X1080 (24p)	View on a Full HDTV.
	1920X1080 (23.98p)	View on a Full HDTV. (Available only with some Smart Filter options.)
	1920X1080 (15p)	View on a Full HDTV. (Available only with some Smart Filter options.)
	1280X720 (60p)	View on an HDTV.
	1280X720 (30p)	View on an HDTV.
	640X480 (60p)	View on a TV.
	640X480 (30p)	View on a TV.
	640X480 (MJPEG)	View on a TV.

## When Video Out is set to PAL

\* Default

Icon	Size	Recommended for
	4096X2160 (24p)	View on a 4K UHD TV.
	3840X2160 (25p)	View on a 4K UHD TV.
	3840X2160 (24p)	View on a 4K UHD TV.
 *	1920X1080 (50p)	View on a Full HDTV. (Videos recorded with this option may not play on some HDTVs or smart phones that do not support 50p.)
	1920X1080 (25p)	View on a Full HDTV.
	1920X1080 (24p)	View on a Full HDTV.
	1920X1080 (12.5p)	View on a Full HDTV. (Available only with some Smart Filter options.)
	1280X720 (50p)	View on an HDTV.
	1280X720 (25p)	View on an HDTV.
	640X480 (50p)	View on a TV.
	640X480 (25p)	View on a TV.
	640X480 (MJPEG)	View on a TV.



When recording a video with , set **HDMI Output** to **4096x2160p** on the camera to ensure that the video will play smoothly on a UHD TV.



## Movie quality

Set the Movie quality.



To set movie quality options,

 In Shooting mode, press [MENU] →  → **Movie Quality** → an option.

\* Default

Icon	Extension	Description
	HEVC, MP4	<b>Normal:</b> Record videos in normal quality.
	HEVC, MP4	<b>HQ*:</b> Record videos in high quality.
	HEVC, MP4	<b>Pro:</b> Record videos in ultra high quality. Available only when the movie size is set to 1920X1080 or higher.



 is a format provided for editing. Video in  may not play smoothly depending on your computer's specifications. We recommend you connect the camera to a UHD TV with an HDMI cable to ensure the video plays smoothly.

## Bit rates for movie sizes

File format	Movie Size		Bit rate (Pro) Mbit/s	Bit rate (HQ) Mbit/s	Bit rate (Normal) Mbit/s	Frame rate	Sensor output
MP4	4K	4096X2160	72	36	29	24p	24p
	UHD	3840X2160	80	40	32	30p	29.97p
			80	40	32	25p	25.00p
			70	35	28	24.00p	24.00p
			70	35	28	23.98p	23.98p
	FHD	1920X1080	40	17	14	60p	59.94p
			40	17	14	50p	50.00p
			18	9	7	30p	29.97p
			18	9	7	25p	25.00p
			16	8	6	24.00p	24.00p
			16	8	6	23.98p	23.98p
	HD	1280X720	-	8	6	60p	59.94p
			-	8	6	50p	50.00p
			-	4.5	3.6	30p	29.97p
			-	4.5	3.6	25p	25.00p
	VGA	640X480	-	2.6	2.1	60p	59.94p
			-	2.6	2.1	50p	50.00p
			-	1.5	1.2	30p	29.97p
			-	1.5	1.2	25p	25.00p

\* The bit rates above may vary depending on the shooting conditions.

\* The bit rates above are based on HEVC codec.







## Fast / Slow Movie

Set the playing speed of a video.

To set playing speed options,

In Shooting mode, press [MENU] →  → **Fast / Slow Movie** → an option.

\* Default

Icon	Description
	<b>x0.25</b> : Record a video to view it at 1/4 normal speed during playback. Available only with 1920X1080 (30p/25p), 1280X720 (30p/25p), 640X480 (30p/25p).
	<b>x0.5</b> : Record a video to view it at 1/2 normal speed during playback. Available only with 1920X1080 (60p/50p/30p/25p), 1280X720 (60p/50p/30p/25p), 640X480 (60p/50p/30p/25p).
	<b>x1*</b> : Record a video to view it at normal speed during playback.
	<b>x5</b> : Record a video to view it at 5X normal speed during playback.
	<b>x10</b> : Record a video to view it at 10X normal speed during playback.
	<b>x20</b> : Record a video to view it at 20X normal speed during playback.



- If you select an option other than **x1**, the sound recording function and the Distortion Correct function will not be supported.
- The available options may differ depending on shooting conditions.

## Gamma Control

Use the gamma settings to adjust color, saturation, sharpness, contrast, and hue to achieve the desired effect.

Gamma represents the relationship between the brightness and luminance displayed on a monitor or camera. When switched to Video recording standby mode or when recording a video, you can view a video with the changed gamma values applied.

To set Gamma Control options,

In Shooting mode, press [MENU] →  → **Gamma Control** → an option.

\* Default

Option	Description
<b>Normal*</b>	Apply standard effects.
<b>Gamma C</b>	Apply increased contrast.
<b>Gamma DR</b>	Apply a wide Dynamic Range.



**Gamma C** or **Gamma DR** cannot use Picture Wizard options at the same time.

## Adjusting the settings

When **Gamma C** or **Gamma DR** is selected, press [DISP] to adjust the settings.

To adjust the gamma settings,

In Shooting mode, press [MENU] →  → **Gamma Control** → move to **Gamma C** or **Gamma DR** → press [DISP] → adjust color, saturation, sharpness, contrast, or hue.

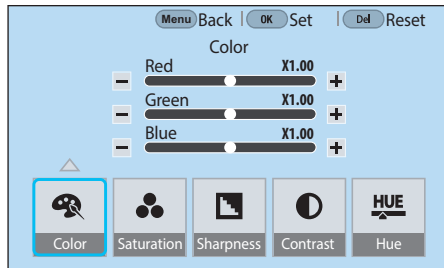

## Master Black Level

Set the Master Black value. The Master Black value (pedestal level) serves as the reference black for the video. If the setting is a positive value, the dark areas in a video become brighter and the contrast decreases. If the setting is a negative value, the dark areas become darker and the contrast increases.

To set the Master Black Level,

In Shooting mode, press [MENU] →  → **Master Black Level** → use command dials 1 and 2 or the navigation button, or drag the slider to adjust the value.

## Luminance Level

Set the luminance level. Luminance is a measure of the light intensity. It indicates how bright the subject will appear when the available light source is reflected on to the subject.

To set the luminance,

In Shooting mode, press [MENU] →  → **Luminance Level** → an option.

## AF Responsiveness

Set the delay time for the focus to automatically change during video recording. When a new subject enters the frame, the camera shifts the focus slowly if the responsiveness is set to low. If the responsiveness is set to high, the camera shifts the focus quickly.

To adjust the AF Responsiveness,

In Shooting mode, press [MENU] →  → **AF Responsiveness** → an option.



- This function is available only when **Fast / Slow Movie** is set to **x1**.
- This function is not available with the following lenses:
  - SAMSUNG 16mm F2.4
  - SAMSUNG 20mm F2.8
  - SAMSUNG 30mm F2
  - SAMSUNG 60mm F2.8 Macro ED OIS SSA
  - SAMSUNG 85mm F1.4 ED SSA
  - SAMSUNG 20-50mm F3.5-5.6 ED II

## AF Shift Speed

Set how fast the auto focus function operates during video recording. A fast shift speed is useful for capturing action shots, such as sporting events. A slow shift speed enables smooth changes of focus depending on the subject.

To adjust the AF Shift Speed,

In Shooting mode, press [MENU] →  → **AF Shift Speed** → an option.



- This function is available only when **Fast / Slow Movie** is set to **x1**.
- This function is not available with the following lenses:
  - SAMSUNG 16mm F2.4
  - SAMSUNG 20mm F2.8
  - SAMSUNG 30mm F2
  - SAMSUNG 60mm F2.8 Macro ED OIS SSA
  - SAMSUNG 85mm F1.4 ED SSA
  - SAMSUNG 20-50mm F3.5-5.6 ED II







## Fader

Use the function appropriately and add dramatic effects on your videos. Set the fade in option to gradually fade in at the start of a scene. Set the fade out option to gradually fade out at the end of a scene.

To set fader options,

In Shooting mode, press [MENU] →  → **Fader** → an option.

\* Default

Icon	Description
	<b>Off*</b> : The fader function is off.
	<b>In</b> : Scene gradually fades in.
	<b>Out</b> : Scene gradually fades out.
	<b>In-Out</b> : The fader function is applied at the start and end of the scene.



When you use the fader function, it may take longer to save a file.

## Voice

Sometimes, a muted video is more appealing than one with sound. Turn Voice off to record a muted video.

To set voice options,

In Shooting mode, press [MENU] →  → **Voice** → an option.

## Wind Cut

When you record videos in noisy environments, unintended sounds can be recorded in videos. In particular, severe wind noise can prevent you from enjoying your videos. Use the Wind Cut function to remove some surrounding noise in addition to wind noise.

To reduce wind sound,

In Shooting mode, press [MENU] →  → **Wind Cut** → an option.

## Mic Level

Set the mic level for the shooting conditions.

To set the mic level,

In Shooting mode, press [MENU] →  → **Mic Level** → rotate the navigation button or press [←/→] to adjust the mic level → touch **Set**.

## Smart Range+

Correct for the loss of bright detail.

To set Smart Range+ options,

In Shooting mode, press [MENU] →  → **Smart Range+** → an option.

## Time Code (HDMI)

Time Code refers to a unique number assigned to each frame of a video file. It is useful for editing because the number is given for each frame and enables the synchronization with other device that outputs different formats. This functions allows the camera to send the time code to an external recorder\* when they are connected via an HDMI cable. If a video is saved on the camera's memory card, the time code will not be recorded.

\* External recorders that support Atomos Protocol v2.0 are currently supported and more recorders will be available soon.

To set Time Code options,

In Shooting mode, press [MENU] →  → **Time Code (HDMI)** → an option.

\* Default

Option	Description
<b>Time Code</b>	Set to display or hide the time code. <ul style="list-style-type: none"> <li>• <b>Off</b>*: Do not display the time code.</li> <li>• <b>On</b>: Display the time code.</li> </ul>
<b>Time Notation</b>	Set the hour, minute, second, and frame manually or set the time code to the camera's time. <ul style="list-style-type: none"> <li>• <b>Manual Settings</b>: Set the hour, minute, second, or frame number of the time code manually.</li> <li>• <b>Camera Time</b>*: Display the time code in the format of the time (hour, minute, second) set on the camera.</li> </ul>
<b>Time Code Mode</b>	Set to automatically adjust the gap between the recording time of the camera and the time code or make no change. <ul style="list-style-type: none"> <li>• <b>Drop Frame</b>*: Automatically adjusts the gap between the recording time of the camera and the time code. This function is generally used when the accurate running time of a video, such as a TV program, is required.</li> <li>• <b>Non-Drop Frame</b>: Do not adjust the gap between the recording time of the camera and the time code.</li> </ul>



Chapter 3

# Playback/Editing

---

Learn about how to play back and edit photos and videos.

# Searching and managing files

Learn how to view photo and video thumbnails and how to protect or delete files.



If you perform no operations for a while, information and icons on the screen disappear. When you press a button or touch the screen, they will reappear.

## Viewing photos

1 Press [▶].

- The most recent file you captured will be displayed.

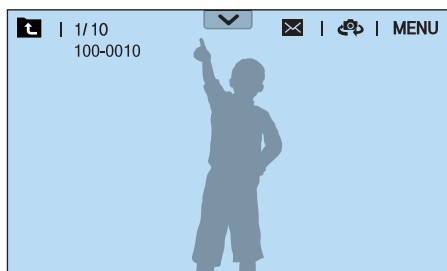

2 Scroll command dial 2 or rotate the navigation button or press [←/→] to scroll through files.

- You can also drag the image left or right to move to another file.



You may not be able to edit or play back files that were captured with other cameras, due to unsupported sizes or codecs. Use a computer or another device to edit or play back these files.

## Viewing image thumbnails

To search for photos and videos you want, change to the thumbnail view. The thumbnail view displays multiple images at a time so that you can easily look for items you want to find. You can also classify and display files by category, such as date or file type.

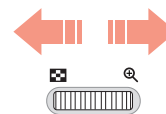
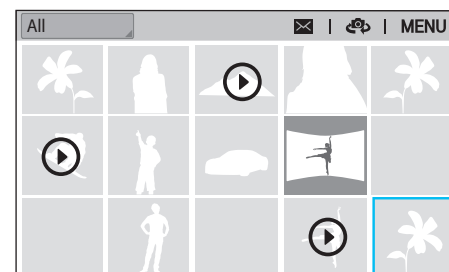

**Scroll command dial 1 to the left to select the thumbnail view mode.**

(Scroll command dial 1 to the right to return to the previous mode.)

## Viewing files by category

- In the thumbnail view, press [MENU] →  → **Filter** → a category.
  - You can also touch the current category name to open the option list.

Option	Description
All*	View files normally.
Date	View files by the date they were saved.
Type	View files by the file type.

\* Default

- Select a list to open it.
- Select a file to view it.
- Touch  to return to the previous view.



## Viewing continuous shots

View continuous shots from a photo bundle. Select a photo bundle to play back all photos in the bundle automatically. If you delete a photo bundle, all photos in the photo bundle will be deleted. The photos in a photo bundle are saved as an individual photo file on the memory card; a separate folder is not created. You can choose to view continuous shots as a bundle or view them separately.

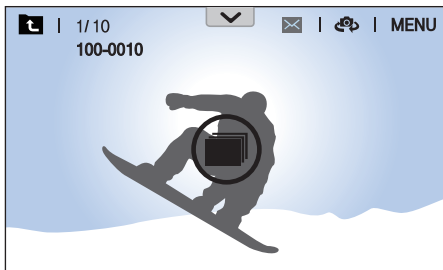

- 1 In Playback mode, scroll command dial 2 or rotate the navigation button or press [←/→] to move to a desired photo bundle.
  - You can also drag the image left or right to move to a desired folder.
  - The camera will automatically play back photos in the photo bundle.
  - Press [MENU] →  → **View Continuous Shots** → **Unfold** to view continuous shots separately.





- 2 Scroll command dial 1 to the right to open the photo bundle.
  - You can also touch the photo bundle on the screen or press [OK] to open the photo bundle.
- 3 Scroll command dial 2 or rotate the navigation button or press [←/→] to move to another file.
  - You can also drag the image left or right to move to another file.
- 4 Scroll command dial 1 to the left or press [OK] to return to Playback mode.
  - You can also touch  to return to Playback mode.

## Protecting files

Protect your files from accidental deletion.

- 1 In Playback mode, press [MENU] →  → **Protect** → **Multiple Protect**.
- 2 Scroll command dial 2 or rotate the navigation button or press [←/→] to move to a file, and then select the file by pressing [].
- 3 Press [].



- You cannot delete or rotate a protected file.
- You can directly protect a file in Playback mode by selecting a file, and then pressing []. To unprotect the file, press [] again.
- Press [] while the photo bundle is selected, to protect all continuous shots in the bundle.

### Lock/Unlock all files

Lock or unlock all files.

- 1 In Playback mode, press [MENU] →  → **Protect** → **Protect All**.
- 2 Select an option.

Option	Description
Cancel	Return to the previous menu.
Unlock	Unlock all files.
Lock	Lock all files.

## Deleting files

Delete files in Playback mode and secure more space on your memory card. Protected files can be deleted once the protection is removed.

### Deleting a single file

You can select a single file and delete it.

- 1 In Playback mode, select a file, and then press [⏏].
- 2 When the pop-up message appears, select **Yes**.

### Deleting multiple files

You can select multiple files and delete them.

- 1 In Playback mode, press [MENU] → [▶] → **Delete** → **Multiple Delete**.
  - In thumbnail view, press [MENU] → [▶] → **Select Item**.
  - Alternatively, in thumbnail view, press [⏏], and then select files to delete.

- 2 Scroll command dial 2 or rotate the navigation button or press [←/→] to move to a file, and then select the file by pressing [OK].
  - Press [OK] again to cancel your selection.
- 3 Press [⏏].
- 4 When the pop-up message appears, select **Yes**.

### Deleting all files

You can delete all files on the memory card at once.

- 1 In Playback mode, press [MENU].
- 2 Select [▶] → **Delete** → **Delete All**.
- 3 When the pop-up message appears, select **Yes**.



# Viewing photos

## Enlarging a photo

You can enlarge photos when viewing them in Playback mode. You can also use the Trim function to extract the portion of the image displayed on the screen and save it as a new file.



Magnification (The maximum magnification may differ by resolution.)

Magnified area

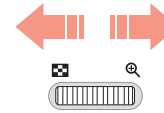

**Scroll command dial 1 to the right to enlarge a photo.**  
(Scroll command dial 1 to the left to reduce a photo.)

To	Do this
Move magnified area	Press [DISP/1/=/-].
Crop the enlarged image	Press [Fn]. (saved as a new file)
Return to the original image	Press [OK].



- You can also pinch your fingers together or spread them apart on the screen to reduce or enlarge a photo. You can also double-tap an area to enlarge it quickly.
- You can scroll through files by rotating the navigation button, even when a photo is enlarged.

## Viewing a slide show

You can view photos in a slide show and apply various effects.

- 1 In Playback mode, press [MENU].
- 2 Select  → **Slide Show Options**.
- 3 Select a slide show effect option.
  - Skip to step 4 to start a slide show with no effects.



\* Default

Option	Description
<b>Play Mode</b>	Set to play a slide show once or repeatedly. ( <b>One Play*</b> , <b>Repeat</b> )
<b>Interval</b>	Set the interval between photos. ( <b>1 sec*</b> , <b>3 sec</b> , <b>5 sec</b> , <b>10 sec</b> )
<b>Effect</b>	<ul style="list-style-type: none"> <li>• Set a scene change effect between photos.</li> <li>• Select <b>Off</b> to cancel effects.</li> </ul>

4 Press [MENU].

5 Select **Start Slide Show**.

6 View the slide show.

- Press [>] to pause.
- Press [>] again to resume.
- Press [MENU] to stop the slide show and return to Playback mode.

## Viewing the overexposure guide

Make the overexposed areas in a photo blink.

To view the overexposure guide,

In Playback mode, press [MENU] →  → **Overexposure Guide** → an option.

## Viewing interval shots

View photos that are captured with the Interval Capture function.

To view interval shots,

In Playback mode, press [MENU] →  → **Play Interval Shots**.

## Sorting files

Sort files by most recent or by oldest.

To set a sorting option,

In Playback mode, press [MENU] →  → **Sort by** → an option.

## Auto rotating

With Auto Rotate on, the camera automatically rotates photos you have captured vertically so they fit the screen horizontally.

To set auto rotate options,

In Playback mode, press [MENU] →  → **Auto Rotate** → an option.

## Converting to JPEG

Convert RAW files to JPG files.





To convert files,

In Playback mode, press [MENU] →  → **Convert to JPG**.

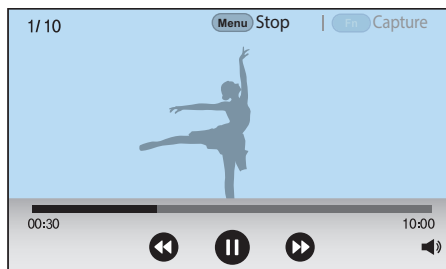
# Playing videos





In Playback mode, you can play a video, capture an image from a video, or crop a video to save as another file.



Icon	Description
	View previous file/Scan backward. (Each time you touch the icon while playing a video, you change the scan speed in this order: 2X, 4X, 8X.)
	Pause or resume playback.
	View next file/Scan forward. (Each time you touch the icon while playing a video, you change the scan speed in this order: 2X, 4X, 8X.)
	Adjust the volume or mute the sound.

## Scanning backward or forward

To scan backward or forward through a video file while it is playing, use one of the following methods.

- Touch  . Each time you touch the icon, you change the scan speed in this order: 2X, 4X, 8X.
- Press [/]. Each time you press the button, you change the scan speed in this order: 2X, 4X, 8X.
- Scroll command dials 1 or 2 or rotate the navigation button to the left or right. Each time you scroll command dials 1 or 2 or rotate the navigation button, you change the scan speed in this order: 2X, 4X, 8X.
- Drag the handles that appear on the progress bar to the left or right. You can change the playback position in the video.



You can pause a video and rotate the navigation button to scan back or forwards. MJPEG files can be scanned in a single frame increment. For MP4 files, scan forward to view single frames or scan back to view in about 0.5 second increment.

## Adjusting the brightness of a video

Adjust the brightness of a video while playing it.

To adjust the brightness of a video,

Touch the left half of the display → drag upward or downward.

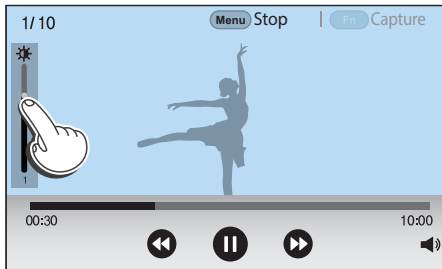



## Adjusting the volume of a video

Adjust the volume of a video while playing it.



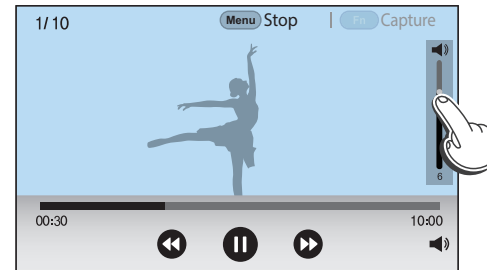

To adjust the volume of a video,

Touch the right half of the display → drag upward or downward.



- You can also touch  and drag the slider on the volume control bar upward or downward.
- You can also press [DISP/II] to adjust the volume of a video.

## Trimming a video during playback

- 1 In Playback mode, scroll to a video, and then press [MENU].
- 2 Select **Trim Movie**.
- 3 Press [OK] or touch  to start playing the video.
- 4 Press [OK] or touch  at the point where you want the trimming to begin.
- 5 Press [Fn] or touch **Start Point**.
- 6 Press [OK] or touch  to resume playing the video.
- 7 Press [OK] or touch  at the point where you want the trimming to end.
- 8 Press [Fn] or touch **End Point**.
- 9 Press [Fn] or touch **Trim** to trim a video.
  - You can adjust the scene to be cropped by dragging the handles that appear on the progress bar.

10 When the pop-up message appears, select **Yes**.



- You cannot trim a video recorded in 3D mode.
- The original video should be at least 10 seconds long.
- The camera will save the edited video as a new file and leave the original video intact.

## Capturing an image during playback

- 1 While viewing a video, press [OK] or touch  at the point where you want to capture an image.
- 2 Press [Fn] or touch **Capture**.



- You cannot capture an image from a video recorded in 3D mode.
- The resolution of the captured image will be the same as the original video.
- The captured image is saved as a new file.

# Editing photos

Perform photo editing tasks, such as resizing or rotating. Edited photos are saved as new files under different file names. Photos captured in some modes cannot be edited with the Image Edit function.





To edit images,

In Playback mode, scroll to a photo, and then press [MENU] →  → **Edit Image** → an option.



- Some images cannot be edited with the Edit Image function. In this case, use the supplied image editing software.
- The camera will save edited photos as new files.
- Edited photos may be converted to a lower resolution.
- You cannot edit photos while viewing continuous shots from a photo bundle. Open the photo bundle and select a photo to edit it.

## Cropping a photo

- 1 Touch  → .
- 2 Drag the sides of the box to adjust the size of the crop area.
- 3 Drag the box to move the location of the crop area.
- 4 Press [] or touch **Done**.
- 5 Touch  to save.

## Rotating a photo

1 Touch  → .

2 Touch an option.

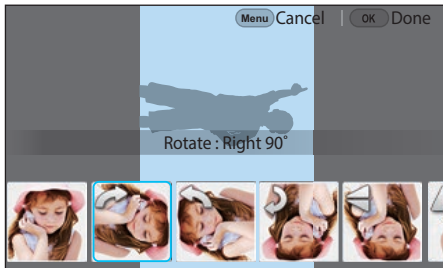

3 Press [] or touch **Done**.

4 Touch  to save.



- You can also rotate a photo in Playback mode by pressing [MENU], and then selecting  → **Rotate** → a desired option.
- The camera will overwrite the original file.

## Resizing photos

Change the size of a photo and save it as a new file.

1 Touch  → .

2 Touch an option.

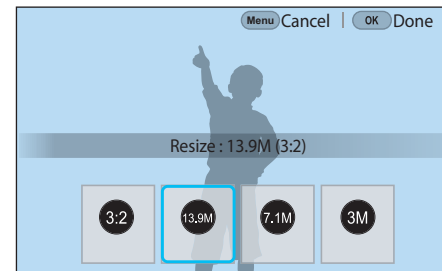

3 Press [] or touch **Done**.

4 Touch  to save.



Available resize options differ depending on the original size of the photo.













## Adjusting your photos



You can correct captured photos by adjusting the brightness, contrast, or color.

1 Touch .

2 Touch an adjusting option.

- If you selected  (Auto adjustment), skip to step 4.

Icon	Description
	Original (Reset to the original image.)
	Auto adjustment
	Brightness
	Contrast
	Saturation
	RGB adjustment
	Color Temperature
	Exposure
	Hue

3 Scroll command dials 1 or 2 or rotate the navigation button or press [/] to adjust the option.



- You can also drag the slider or touch +/- to adjust the option.

4 Press [] or touch **Done**.

5 Touch  to save.

## Retouching faces

1 Touch  → .

2 Scroll command dials 1 or 2 or rotate the navigation button or press [/] to adjust the option.

- You can also drag the slider or touch +/- to adjust the option.
- As the number increases, the skin tone becomes brighter and smoother.

3 Press [] or touch **Done**.

- To cancel correction, touch .

4 Touch  to save.

## Applying Smart Filter effects

Apply special effects to your photos.

1 Touch , and then touch an option.

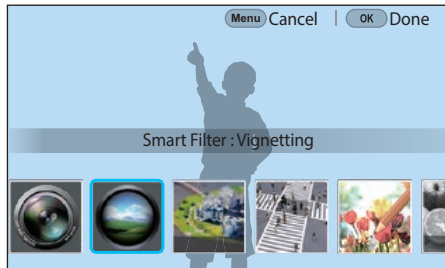

Option	Description
Original	No effect
Vignetting	Apply the retro-looking colors, high contrast, and strong vignette effect of Lomo cameras.
Miniature (H)	Apply a tilt-shift effect to make the subject appear in miniature. The top and bottom of the photo will be blurred.

Option	Description
Miniature (V)	Apply a tilt-shift effect to make the subject appear in miniature. The left and right of the photo will be blurred.
Watercolor	Apply a watercolor painting effect.
Red	Desaturate all colors but red.
Green	Desaturate all colors but green.
Blue	Desaturate all colors but blue.
Yellow	Desaturate all colors but yellow.

2 Press  or touch **Done**.

3 Touch  to save.



## Chapter 4

# Connecting & Transferring

---

Learn how to share photos or videos and use various features.

# Connecting to a smart phone

## Using the NFC Feature

Place a smart phone's NFC antenna near the camera's NFC tag to connect the camera to the smart phone. You can also transfer files to an NFC-enabled device in Playback mode.



- This feature is supported by NFC-enabled smart phones running the Android OS. We recommend that you use the latest version. This feature is not available for iOS devices.
- You should install Samsung Camera Manager on your phone or device before using this feature. Download and install Samsung Camera Manager Inst. from the Google Play Store to install Samsung Camera Manager. Samsung Camera Manager is compatible with the Samsung NX1 camera and is supported by Android OS 4.2.2 or higher.
- To read an NFC tag, place the NFC-enabled device near the camera's NFC tag for more than 2 seconds.
- You can set the size for transferred photos by pressing [MENU], and then selecting  $\text{⌘}$  → **MobileLink/NFC Image Size** → an option.
- Do not modify the NFC tag in any way.

## Using NFC features in Shooting mode

In Shooting mode, connect a camera and a smart phone by placing the NFC antenna of one device near the NFC tag of the other. Press [ $\text{⌘}$ ] or turn on Samsung Camera Manager on the smart phone, and then launch MobileLink, Remote Viewfinder, Quick Transfer, or Pro Suggest Market. (p. 156, 158, 161)

## Using NFC features in Playback mode (Photo Beam)

In Playback mode, the camera transfers the current files to the smart phone automatically when you place the two devices close to each other while they are connected via Bluetooth.

- To transfer multiple files, select files from the thumbnail view, and then read a tag from an NFC-enabled device.



## Using the GPS Geo Tagging Feature

To save GPS information when you take a photo using the camera, connect the camera and smart phone via Bluetooth. Then, activate the GPS feature on the smart phone.

## Sending files to a smart phone

You can use the MobileLink feature to easily send photos to your smart phone.



- The MobileLink feature is supported by smart phones or tablets running the Android OS or iOS. (Some features may not be supported by some models.) Before using this feature, update the device's firmware to the latest version. If the firmware version is not the most recent, this function may not perform properly.
- You should install Samsung Camera Manager on your phone or device before using this feature. Download and install Samsung Camera Manager Inst. from the Google Play Store or the Apple App Store to install Samsung Camera Manager. Samsung Camera Manager is compatible with the Samsung NX1 camera and is supported by Android OS 4.2.2 or higher or iOS 6.1 or higher.
- If there are no files in the camera's memory, you cannot use this feature.
- You can view up to 1,000 recent files and send up to 1,000 files at a time.
- When using this feature on an iOS device, the device may lose its Wi-Fi connection.
- You cannot send RAW files.
- You can set the size for transferred photos by pressing [MENU], and then selecting  → **MobileLink/NFC Image Size** → an option.
- The screen turns off if you perform no operations on the camera for 30 seconds.
- You can also touch  in Playback mode, and then select .

### 1 In Shooting mode, press [].

- You can also press and hold [] to launch the MobileLink feature directly.

### 2 Touch .

- If the pop-up message that prompts you to download the application appears, select **Next**.
- If you use a Wi-Fi manual connection to connect the camera and a smart phone, you can enable the Wi-Fi Privacy lock. (p. 195)
- If you use a Wi-Fi manual connection to connect the camera and a smart phone, the Bluetooth feature is not available.

### 3 On the smart phone, turn on Samsung Camera Manager.

- To start the application automatically on an NFC-enabled smart phone, turn on the function and place the smart phone near the NFC tag (p. 34) on the camera. Verify that the smart phone is connected to your camera, and then skip to step 6.

- 4 Select the camera from the list on the smart phone.
  - The smart phone can connect to only one camera at a time.
  - If the Wi-Fi Privacy lock is enabled and Wi-Fi is connected, enter the PIN displayed on the camera into the smart phone.
- 5 On the camera, allow the smart phone to connect to your camera or confirm the registration request.
  - If the smart phone has been connected to your camera before, it is connected automatically.
  - If the pop-up message that prompts you to set the auto time setting appears, select **Yes** to sync the camera's date and time to the smart phone's. (p. 195)
- 6 Select files to transfer.
- 7 On the smart phone, touch .
  - The camera will send the files to the smart phone.



## Controlling the camera remotely with a smart phone

Use the Remote Viewfinder feature on your smart phone to control your camera and remotely capture a photo or record video.



- The Remote Viewfinder feature is supported by smart phones or tablets running the Android OS or iOS. (Some features may not be supported by some models.) Before using this feature, update the device's firmware to the latest version. If the firmware version is not the most recent, this function may not perform properly.
- You should install Samsung Camera Manager on your phone or device before using this feature. Download and install Samsung Camera Manager Inst. from the Google Play Store or the Apple App Store to install Samsung Camera Manager. Samsung Camera Manager is compatible with the Samsung NX1 camera and is supported by Android OS 4.2.2 or higher or iOS 6.1 or higher.
- This function is not available when you attach a 3D lens in 3D mode.

1 In Shooting mode, press [.





2 Touch .

- If the pop-up message that prompts you to download the application appears, select **Next**.
- If you use a Wi-Fi manual connection to connect the camera and a smart phone, you can enable the Wi-Fi Privacy lock. (p. 195)
- If you use a Wi-Fi manual connection to connect the camera and a smart phone, the Bluetooth feature is not available.

3 On the smart phone, turn on Samsung Camera Manager.

- To start the application automatically on an NFC-enabled smart phone, turn on the function and place the smart phone near the NFC tag (p. 34) on the camera. Verify that the smart phone is connected to your camera, and then skip to step 6.

- 4 Select the camera from the list on the smart phone.
  - The smart phone can connect to only one camera at a time.
  - If the Wi-Fi Privacy lock is enabled and Wi-Fi is connected, enter the PIN displayed on the camera to the smart phone.
- 5 On the camera, allow the smart phone to connect to your camera or confirm the registration request.
  - If the smart phone has been connected to your camera before, it is connected automatically.
  - If the pop-up message that prompts you to set the auto time setting appears, select **Yes** to sync the camera's date and time to the smart phone's. (p. 195)
- 6 On the smart phone, select  to open the smart panel.
- 7 On the smart phone, set the shooting options.
  - While using this feature, some buttons are not available on your camera.
  - The zoom button and the shutter button on your smart phone will not function when using this feature.
  - Some shooting options are not supported.
  - Shooting options that you have set will remain on the camera after the connection with the smart phone has ended.

- 8 Touch  to return to the shooting screen.
- 9 On the smart phone, touch and hold  to focus, and then release it to capture the photo.
  - Touch  to record a video and touch  to stop a video.
  - Touch  to view the captured photo and send it to the smart phone.
  - If the GPS feature is activated on the smart phone, the GPS information will be saved with the captured photo.



- When you use this feature, the ideal distance between the camera and the smart phone may vary, depending on your surroundings.
- The smart phone must be within 23 ft (7 m) of the camera to use this feature.
- It will take some time to capture the photo after you release  on the smart phone.
- The Remote Viewfinder function will deactivate when:
  - You answer an incoming call on the iOS devices.
  - There is an incoming call on the smart phone.
  - Either the camera or the smart phone turns off.
  - The device loses a Bluetooth or Wi-Fi connection.
  - The Bluetooth or Wi-Fi connection is poor or unstable.
  - You perform no operations for approximately 3 minutes while connected.



## Using a smart phone as a remote shutter release







Use the Bluetooth Shutter function in Samsung Camera Manager on the smart phone to use the smart phone as a remote shutter for the camera.



- This feature is supported by smart phones running the Android OS. We recommend that you use the latest version. This feature is not available for iOS devices.
- You should install Samsung Camera Manager on your phone or device before using this feature. Download and install Samsung Camera Manager Inst. from the Google Play Store to install Samsung Camera Manager. Samsung Camera Manager is compatible with the Samsung NX1 camera and is supported by Android OS 4.2.2 or higher.

- 1 Connect the camera and a smart phone via Bluetooth.
- 2 On the smart phone, turn on Samsung Camera Manager.
- 3 Select **Bluetooth Shutter**.

4 On the smart phone, touch  to capture the photo.

- Select **Press** and touch  to capture a single photo at each time you touch .
- Select **Press & Hold** and touch  to allow [**Shutter**] remain pressed. Press  again to release [**Shutter**]. When capturing continuous shots or using the Bulb function, select **Press & Hold** and touch  to capture photos for the desired time.
- Touch  to start recording a video and touch  to stop a video.





- The ideal distance for a Bluetooth connection between devices may vary, depending on your surroundings and your smart phone.
- The smart phone must be within 23 ft (7 m) of the camera to use this feature.
- The Bluetooth Shutter function will deactivate when:
  - There is an incoming call on the smart phone.
  - Either the camera or the smart phone turns off.
  - The device loses a Bluetooth connection.
  - The Bluetooth connection is poor or unstable.

## Saving files to a smart phone automatically

When you capture a photo with your camera, the photo is saved to a smart phone automatically using the Quick Transfer feature.



- The Quick Transfer feature is supported by smart phones or tablets running the Android OS. (Some features may not be supported by some models.) Before using this feature, update the device's firmware to the latest version. If the firmware version is not the most recent, this function may not perform properly.
- You should install Samsung Camera Manager on your phone or device before using this feature. Download and install Samsung Camera Manager Inst. from the Google Play Store to install Samsung Camera Manager. Samsung Camera Manager is compatible with the Samsung NX1 camera and is supported by Android OS 4.2.2 or higher.
- If you set this function, the setting is maintained even when you change the Shooting mode.
- This feature may not be supported in some modes or may not be available with some shooting options.
- The Quick Transfer feature is only supported via a Bluetooth connection.
- You cannot use the Quick Transfer feature if the camera is connected to a smart phone that does not support Bluetooth via a Wi-Fi connection.
- If a smart phone that does not support Bluetooth is registered to the camera, you must delete it and register a smart phone that supports Bluetooth.

- 1 In Shooting mode, touch .
  - You can also press [, and then select .
  - If the pop-up message that prompts you to download the application appears, select **Next**.
- 2 On the smart phone, turn on Samsung Camera Manager.
  - To start the application automatically on an NFC-enabled smart phone, turn on the function and place the smart phone near the NFC tag (p. 34) on the camera. Verify that the smart phone is connected to your camera, and then skip to step 5.
- 3 Select the camera from the list on the smart phone.
  - The smart phone can connect to only one camera at a time.

#### 4 On the camera, confirm the smart phone's registration request.

- If the smart phone has been connected to your camera before, it is connected automatically.
- The Quick Transfer icon on the camera's screen will be changed to an icon that shows the connection status (📶).
- If the pop-up message that prompts you to set the auto time setting appears, select **Yes** to sync the camera's date and time to the smart phone's. (p. 195)

#### 5 Capture a photo.

- The captured photo is saved to the camera in its original size and a preview image is transferred to the smart phone. Select the preview image on the smart phone to transfer the original photo from the camera to the smart phone.
- If you captured continuous photos, the first captured photo is transferred to the smart phone.
- If the GPS feature is activated on the smart phone, the GPS information will be saved with the captured photo.



# Sending photos via email

Connect to a network and send stored photos on the camera via email.

## Connecting to a WLAN

Learn to connect via an access point (AP) when you are in a range of a WLAN. You can also configure network settings.

1 In Playback mode, touch .

- The camera automatically searches for available AP devices.
- If a pop-up message about data collection regulations appears, read and agree to it.

2 Select an AP.

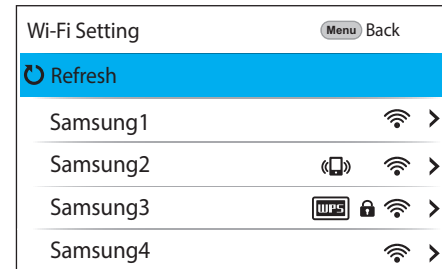

- Select **Refresh** to refresh the list of connectable APs.
- Select **Add wireless network** to add an AP manually. When you add an AP manually, the AP name must be in English.

Icon	Description
	Ad hoc AP
	Secured AP
	WPS AP
	Signal strength
	Press [←] (right) or touch > to open network setting options.

- When you select a secured AP, a pop-up window appears. Enter the required passwords to connect to the WLAN. For information about entering text, refer to “Entering text”. (p. 167)

- When a login page appears, refer to “Using the login browser” (p. 165)
- When you select an unsecured AP, the camera will connect to the WLAN.
- If you select a WPS profile supported AP, select > → **WPS PIN connection**, and then enter a PIN on the AP device. You can also connect to a WPS profile supported AP by selecting > → **WPS button connection** on the camera, and then pushing the **WPS** button on the AP device.
- The same AP may be listed twice, with different frequencies, because your camera supports the dual band function.

### Setting network options

- 1 In the Wi-Fi Setting screen, move to an AP, and then press [←] (right) or touch >.
- 2 Select each option, and then enter the required information.

Option	Description
Network Password	Enter the network password.
IP Setting	Set the IP address automatically or manually.





### Manually setting the IP address

- 1 In the Wi-Fi Setting screen, move to an AP, and then press [←] (right) or touch >.
- 2 Select **IP Setting** → **Manual**.
- 3 Select each option, and then enter the required information.

Option	Description
IP	Enter the static IP address.
Subnet Mask	Enter the subnet mask.
Gateway	Enter the gateway.
DNS Server	Enter the DNS address.

## Using the login browser

You can enter your log-in information via the log-in screen when connecting to some access points.

Icon	Description
	Close the login browser.
	Move to the previous page.
	Move to the next page.
	Stop loading the page.
	Reload the page.



- You may not be able to select some items depending on the page you connected to. This does not indicate a malfunction.
- The login browser may not close automatically after you log into some pages. If this occurs, close the login browser by touching **EXIT**, and then proceed with the desired operation.
- It may take longer to load the login page due to the page size or network speed. If this occurs, wait until the login information input window appears.





## Network connection tips

- You must insert a memory card to use the Wi-Fi features.
- The quality of the network connection will be determined by the AP.
- The further the distance between your camera and the AP, the longer it will take to connect to the network.
- If a nearby device is using the same radio frequency signal as your camera, it may interrupt your connection.
- If your AP name is not in English, the camera may not be able to locate the device or the name may appear incorrectly.
- For network settings or a password, contact your network administrator or network service provider.
- If a WLAN requires authentication from the service provider, you may not be able to connect to it. To connect to the WLAN, contact your network service provider.
- Depending on the encryption type, the number of digits in the password may differ.
- A WLAN connection may not be possible in all surroundings.
- The camera may display a WLAN enabled printer on the AP List. You cannot connect to a network via a printer.
- You cannot connect your camera to a network and a TV simultaneously.
- Connecting to a network may incur additional charges. Costs will vary based on the conditions in your contract.
- If you cannot connect to a WLAN, try another AP from the available AP list.
- A login page may appear when you select free WLANs provided by some network service providers. Enter your ID and password to connect to the WLAN. For information about registering or the service, contact the network service providers.
- Be cautious when you enter personal information for an AP connection. Do not enter any payment or credit card information on your camera. The manufacturer is not liable for any problem caused by entering such information.
- Available network connections may differ by country.
- The WLAN feature of your camera must comply with radio transmission laws in your region. To ensure compliance, use the WLAN feature only in the country where you purchased the camera.
- The process for adjusting network settings may differ, depending on network conditions.
- Do not access a network that you are not authorized to use.
- Before you connect to a network, ensure your battery is fully charged.
- Files that you transfer to another device may not be supported by the device. In this case, use a computer to play back the files.

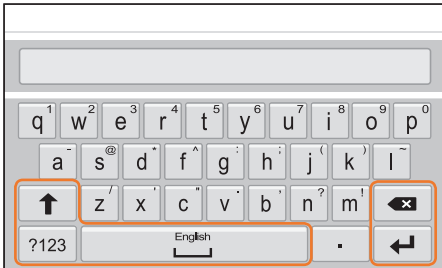
## Entering text

Learn how to enter text. The icons in the table let you move the cursor, change the case, etc. Touch a key to enter it.



Icon	Description
	Change case.
	Switch between Symbol/Number mode and the normal mode.
	<ul style="list-style-type: none"> <li>• Touch to enter a space.</li> <li>• Change the input language by dragging it to the left or the right.</li> </ul>
	Save the displayed text.
	Delete the last letter.











- You can use only the English alphabet in some modes, regardless of the display language.
- The number of characters you can enter varies depending on the situation.
- The screen may differ depending on the input mode.
- Touch and hold a key to enter the character at the upper right corner of the key.



## Sending photos via email

You can send photos stored on the camera via email. For information about entering text, refer to “Entering text”. (p. 167)

- 1 In Playback mode, touch 
  - In thumbnail view, select  → a file, and then press [Fn]. You can select up to 5 files. The total size must be 7 MB or less.
- 2 Connect to a WLAN. (p. 163)
- 3 Select the **Sender** box, enter your email address, and then touch 
  - If you have previously saved your information, it will be inserted automatically. (p. 169)
  - To use an address from the list of previous senders, select  → an address.
- 4 Select the **Receiver** box, enter an email address, and then touch 
  - To use an address from the list of previous recipients, select  → an address.
  - Select  to add additional recipients. You can input up to 30 recipients.
  - Select  to delete an address from the list.
- 5 Select **Next**.
- 6 Select the comment box, enter your comments, and then touch .
- 7 Select **Send**.
  - The camera will send the email.
  - If an email fails to send, a message prompting you to send it again appears.



- Even if a photo appears to have transferred successfully, errors with the recipient's email account may cause the photo to be rejected or recognized as spam.
- You may not be able to send an email if no network connection is available or if your email account settings are incorrect.
- You cannot send an email if the combined file sizes exceed the 7 MB. If the selected photo has a resolution higher than 2M, it will be automatically resized to a lower resolution.
- If you cannot send an email because of firewall or user authentication settings, contact your network administrator or network service provider.
- If there are no files in the camera's memory, you cannot use this feature.

### Storing a sender's information

In the email menu, you can change settings for storing a sender's information. For information about entering text, refer to "Entering text". (p. 167)

1 In Playback mode, touch .

- The camera will automatically attempt to connect to a WLAN via the most recently connected AP device.
- If the camera has not previously been connected to a WLAN, it will search for available AP devices. (p. 163)

2 Press [Fn].

3 Select **Sender Setting**.

4 Select the **Name** box, enter your name, and then touch .

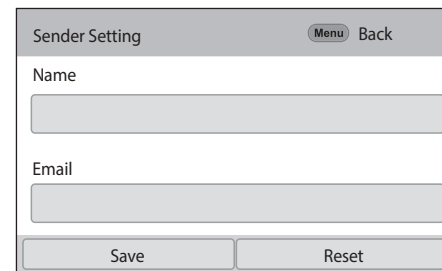

Sender Setting Menu Back

Name

Email

Save Reset

5 Select the **Email** box, enter your email address, and then touch .

6 Select **Save** to save your changes.  
• To delete your information, select **Reset**.

### Setting an email password

In the email menu, you can set the email password. For information about entering text, refer to "Entering text". (p. 167)

1 In Playback mode, touch .

- The camera will automatically attempt to connect to a WLAN via the most recently connected AP device.
- If the camera has not previously been connected to a WLAN, it will search for available AP devices. (p. 163)

2 Press [Fn].

3 Select **Setting Password** → **On**.

- To deactivate the password, select **Off**.

4 When the pop-up appears, select **OK**.

5 Enter a 4-digit password.

6 Enter the password again.

7 When the pop-up appears, select **OK**.



If you lose your password, you can reset it by selecting **Reset** on the password setting screen. When you reset the information, the previously saved user's setting information and email address will be deleted.

## Changing the email password

In the email menu, you can change the email password. For information about entering text, refer to “Entering text”. (p. 167)





- 1 In Playback mode, touch .
    - The camera will automatically attempt to connect to a WLAN via the most recently connected AP device.
    - If the camera has not previously been connected to a WLAN, it will search for available AP devices. (p. 163)
- 2 Press [Fn].
  - 3 Select **Change Password**.
  - 4 Enter your current 4-digit password.
  - 5 Enter a new 4-digit password.
  - 6 Enter the new password again.
  - 7 When the pop-up appears, select **OK**.





# Viewing photos or videos on a TV

Use the Wi-Fi feature or USB cable to play back files from the camera on a TV that supports home networking features.

## Connecting wirelessly

- 1 In Playback mode, touch .
- 2 Select  or .
  - If the guide message appears, select **OK**.
  - The camera will automatically attempt to connect to a WLAN via the most recently connected AP device.
  - If the camera has not previously been connected to a WLAN, it will search for available AP devices. (p. 163)
  - If you select , a list of files that can be shared with the TV is displayed on the camera. Wait until other devices detect your camera.
- 3 Connect your TV to a network, and then activate the corresponding feature.
  - Refer to the TV's user manual for more information.

## 4 Connect the camera to a TV.

- If you select , choose a TV to connect to from the list on the camera.
- If you select , enable the TV, and then choose your camera from the list on the TV to connect to it.

## 5 Browse the shared photos or videos.

- For information about searching for the camera and browsing the photos or videos on your TV, refer to the TV's user manual.
- Videos may not play smoothly depending on the type of your TV or the network condition. For smooth playback, use a 5 GHz dual-band AP device.

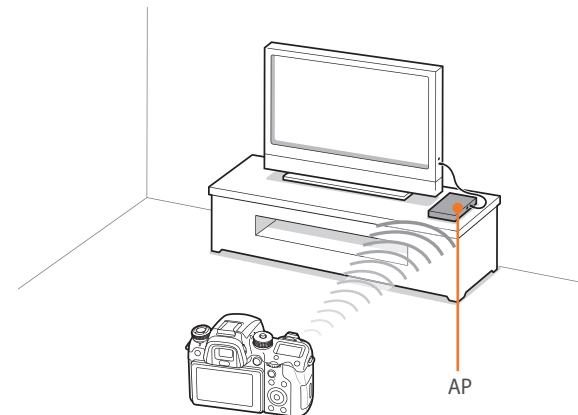

▲ The camera is connected to a TV via a wireless network.



- You can share up to 1,000 recent files.
- On the TV, you can view only photos or videos captured with your camera.
- The range of the wireless connection between your camera and a TV may vary depending on the specifications of the AP.
- If the camera is connected to two TVs, playback may be slower.
- Photos or videos will be shared in their original sizes.
- You can only use this feature with a TV that supports home networking features.
- Shared photos or videos will not be stored on the TV, but they can be stored in the camera to meet the TV's specifications.
- Transferring photos or videos to the TV may take some time depending on the network connection, the number of files to be shared, or the sizes of the files.
- If you power off the camera abnormally while viewing photos or videos on a TV (for example, by removing the battery), the TV considers the camera to still be connected.
- The order of photos or videos on the camera may be different than on the TV.
- Depending on the number and sizes of photos or videos you want to share, it may take some time to load your files and complete the initial set-up process.
- While viewing photos or videos on the TV, continuously using the TV's remote or performing additional operations on the TV may prevent this feature from working properly.

- If you reorder or sort files on the camera while viewing them on a TV, you must repeat the initial set-up process to update the list of files on the TV.
- If there are no files in the camera's memory, you cannot use this feature.
- We recommend you use a network cable to connect your TV to your AP. This will minimize any video 'stuttering' you may experience when streaming content.
- To view files on your TV, enable multicast mode on your AP.
- 1920X1080 (60p) videos can be played only on Full HDTVs or UHD TVs capable of playback at 60p.
- You can view 3D files only on 3D-compatible TVs or monitors.
- Video playback may not be available on devices that do not support HEVC codecs.
- UHD video playback may not work properly on some TVs.

## Connecting via cable

Play back photos or videos by connecting your camera to an HDMI-supported TV using an optional HDMI cable.

### Viewing files on a TV

- 1 In Shooting or Playback mode, press [MENU] →  → **HDMI Output** → an option. (p. 193)
- 2 Turn off your camera and TV.
- 3 Connect your camera to your TV with an HDMI cable.

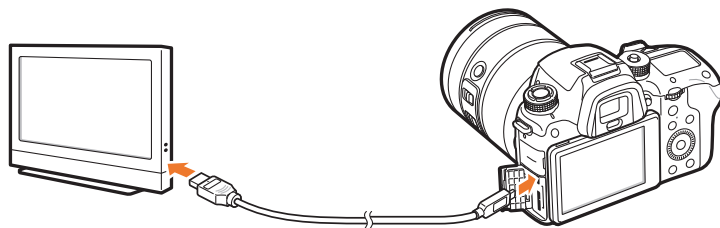

- 4 Turn on your TV and select the HDMI source.
- 5 Turn on the camera.

## 6 View photos or play videos using the camera buttons.



- If your TV supports Anynet+(CEC), you can connect the camera to the TV with an HDMI cable using the Anynet+(CEC) method.
- The Anynet+(CEC) functions allow you to control connected devices using the TV remote control.
- If the TV supports Anynet+(CEC), the TV turns on automatically when used in conjunction with the camera. This feature may not be available on some TVs.
- You can capture photos and videos when the camera is connected to a TV, but some functions will be limited. Shooting functions are supported only when **HDMI Output** is set to **1920x1080p** or **Auto** on the camera and the TV's HDMI output option is set to 1920x1080p.
- When connected to a TV, some of the camera's playback functions may not be available.
- The length of time required to connect the camera and a TV may vary depending on the memory card being used. As the main feature of a memory card is to increase the transfer speed, it is not necessarily true to say that a memory card with a faster transfer speed is also fast in using the HDMI function.
- 1920X1080 (60p) videos can be played only on Full HDTVs or UHD TVs capable of playback at 60p.
- To view 3D photos on a TV that does not support the 3D function, press the  button to switch to Anaglyph mode and wear anaglyph glasses.
- You can also play back or capture photos or videos when you connect the camera to an HDMI-enabled monitor. Connections and their capabilities may vary depending on the monitor. Refer to the monitor's manual for more details.
- UHD video playback may not work properly on some TVs.

### Viewing files on a 3D TV

You can view photos or videos captured in 3D mode on a 3D TV.

- 1 In Shooting or Playback mode, press [MENU] → ⚙️ → **HDMI Output** → an option. (p. 193)
- 2 Turn off your camera and 3D TV.
- 3 Connect your camera to your 3D TV with the optional HDMI cable.

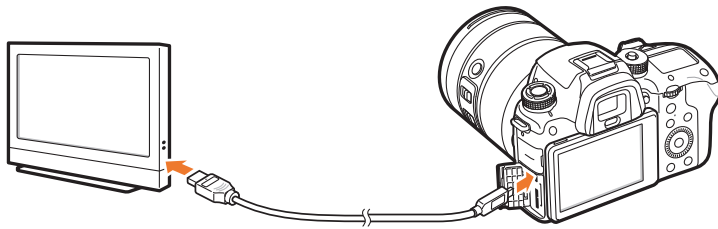

- 4 Turn on your 3D TV, and then select the HDMI video source.
- 5 Turn on your camera.

- 6 Move to a 3D file, and then press [II] to switch to 3D mode.
  - Press [II] again to switch to 2D Mode.
- 7 Turn on your TV's 3D function.
  - Refer to your TV's user manual for more details.
- 8 View 3D photos or play 3D videos using the camera buttons.



- You cannot view an MPO file in 3D on TVs that do not support the file format.
- Use proper 3D glasses when you view an MPO file or a 3D video file on a 3D TV.



Do not view the 3D photos or videos captured by your camera on a 3D TV or 3D monitor for an extended period of time. It may cause unpleasant symptoms, such as eyestrain, fatigue, nausea, and more.



# Connecting to a computer

## Using Auto Backup for photos or videos

You can send photos or videos that you captured with the camera to a PC wirelessly.



### Installing the program for Auto Backup on your PC

- 1 In Shooting or Playback mode, press [MENU] →  → **USB Connection** → **Mass Storage**. (p. 194)
- 2 Connect the camera to the PC with the USB cable.
- 3 Turn on the i-Launcher program, and then select **PC Auto Backup**.
  - The Auto Backup program is installed on the PC. Follow the on-screen instructions to complete the installation.
- 4 Remove the USB cable.



Before installing the program, ensure that the PC is connected to a network.

### Using the Auto Backup feature

- 1 In Playback mode, select a file, and then touch  → .
  - In thumbnail view, you cannot use the Auto Backup feature.
  - If the pop-up message that prompts you to download the application appears, select **Next**.
  - The camera will automatically attempt to connect to a WLAN via the most recently connected AP device.
  - If the camera has not previously been connected to a WLAN, it will search for available AP devices. (p. 163)
- 2 Select a backup PC.

### 3 Select **OK**.

- To cancel sending, select **Cancel**.
- You cannot select individual files to backup. This function backs up only new files on the camera.
- The backup's progress will be shown on the PC monitor.
- When the transfer is completed, the camera will turn off automatically in approximately 30 seconds. Select **Cancel** to return to the previous screen and prevent the camera from turning off automatically.
- To turn off your PC automatically after the transfer is complete, select **Shut down PC after backup**.
- To change the backup PC, select **Change PC**.



- When you connect the camera to the WLAN, select the AP that is connected to the PC.
- The camera will search for available access points even if you are connecting to the same access point again.
- If you turn off the camera or remove the battery while sending files, the file transfer will be interrupted.
- While you are using this feature, the shutter control is disabled on your camera.
- You can connect only one camera to the PC at a time for sending files.
- The backup may be canceled due to network conditions.
- If there are no files in the camera's memory, you cannot use this feature.
- You must turn off Windows Firewall and any other firewalls before using this feature.
- You can send up to 1,000 recent files.
- On the PC software, the server name must be entered in the Latin alphabet and can contain no more than 48 characters.
- When multiple file types are created at once, only the image files (JPG) will be sent to the PC with this feature.

## Connecting the camera as a removable disk

Transfer files on a memory card to your computer by connecting the camera to the PC.

### Transferring files to your Windows OS computer

You can connect the camera to your computer as a removable disk. Open the removable disk and transfer files to your computer.

- 1 In Shooting or Playback mode, press [MENU] → ⚙ → **USB Connection** → **Mass Storage**. (p. 194)
- 2 Turn off the camera.
- 3 Connect the camera to your computer with the USB cable.

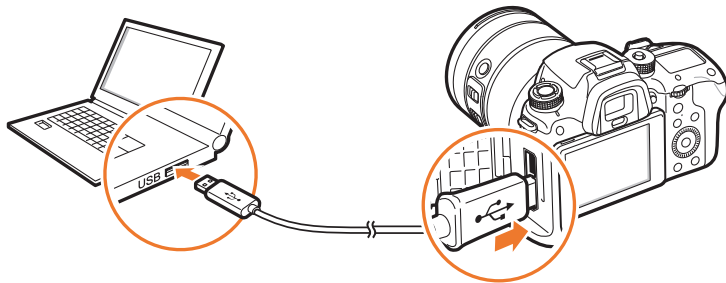

- You must plug the small end of the USB cable into your camera. If the cable is reversed, it may damage your files. The manufacturer is not responsible for any loss of data.
- If you try to plug the USB cable into the HDMI port, the camera may not work properly.
- When using a USB 2.0 cable, plug the USB cable into the lower part of the USB port. If the plug connectors are forced, the device may be damaged. The manufacturer is not responsible for any loss of data.



When using a USB 3.0 cable (optional), connect the USB cable as shown in the illustration.

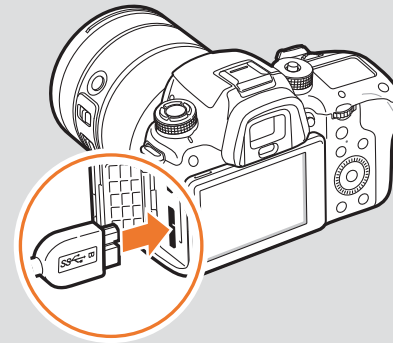



- 4 Turn on the camera.
  - The computer recognizes the camera automatically.
- 5 On your computer, select **My Computer** → **Removable Disk** → **DCIM** → **100PHOTO** or **101\_0101**.
- 6 Select the files you want, and then drag or save them to your computer.



If the **Folder Type** is set to **Date**, the folder name appears as "XXX\_MMDD". For example, if you capture a photo on January 1, the folder name will be "101\_0101".

### Disconnecting the camera (for Windows 7)

When the camera is connected to the computer as a removable disk, follow the instructions below to disconnect the camera. With Windows Vista and Windows 8, the methods for disconnecting the camera are similar.

- 1 Ensure that no data is being transferred between the camera and the computer.
  - If the status lamp on your camera is blinking, it means the data transfer is in progress. Please wait until the status lamp stops blinking.
- 2 Click  on the tool bar at the bottom right of your computer screen.A screenshot of a Windows taskbar showing the system tray area. The USB icon, which is a green square with a white USB symbol, is highlighted with a red square. To its right are the volume and network icons, and the time "10:30 AM".
- 3 Click the pop-up message.
- 4 Click the message box indicating safely removed.
- 5 Remove the USB cable.

## Transferring files to your Mac OS



Mac OS 10.7 or later is supported.

- 1 In Shooting or Playback mode, press [MENU] → ⚙️ → **USB Connection** → **Mass Storage**. (p. 194)
- 2 Turn off the camera.
- 3 Connect the camera to your computer with the USB cable.

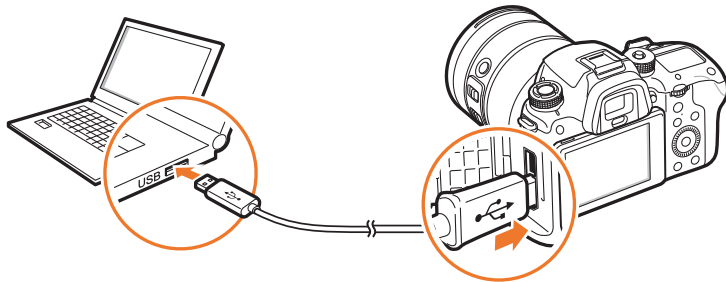

- You must plug the small end of the USB cable into your camera. If the cable is reversed, it may damage your files. The manufacturer is not responsible for any loss of data.
- If you try to plug the USB cable into the HDMI port, the camera may not work properly.
- When using a USB 2.0 cable, plug the USB cable into the lower part of the USB port. If the plug connectors are forced, the device may be damaged. The manufacturer is not responsible for any loss of data.



When using a USB 3.0 cable (optional), connect the USB cable as shown in the illustration.

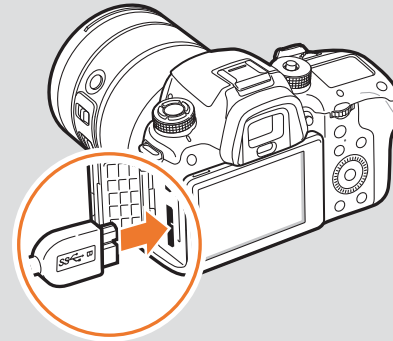

- 4 Turn on the camera.
  - The computer recognizes the camera automatically and displays a removable disk icon.
- 5 On your computer, open the removable disk.
- 6 Select the files you want, and then drag or save them to your computer.

## Chapter 5

# Camera settings menu

---

Learn about the user settings and general settings menu.  
You can adjust the settings to better suit your needs and preferences.

# User settings

You can set the user environment with these settings.

To set user options,

In Shooting mode, press [MENU] →  → an option.



Available items and their order may differ depending on shooting conditions.

## Manage Custom Mode

Create your own shooting modes by adjusting options and saving them.  
Open saved custom modes or delete them. (p. 77)

## Noise Reduction

Use Noise Reduction to reduce the visual noise in photos.

\* Default

Option	Description
High ISO NR	This function reduces noise that may occur when you set a high ISO sensitivity. ( <b>Off</b> , <b>High</b> , <b>Normal*</b> , <b>Low</b> )
Long Term NR	This function reduces noise when you set the camera for a long exposure. ( <b>Off</b> , <b>On*</b> )

## Color Space

The color space option allows you to select methods for representing colors. Digital imaging devices such as digital cameras, monitors, and printers have their own color ranges, referred to as color spaces.

Option	Description
sRGB*	sRGB (Standard RGB) is an international specification that defines the color space created by IEC (International Electrotechnical Commission). It is widely used for creating colors on PC monitors and is also the standard color space for Exif. For regular images and images that will be published on the Internet, we recommend using sRGB.
Adobe RGB	Adobe RGB is used for commercial printing and has a larger color range than sRGB. Its wider range of colors helps you easily edit photos on a computer. Note that individual programs are generally compatible with a limited number of color spaces.

\* Default

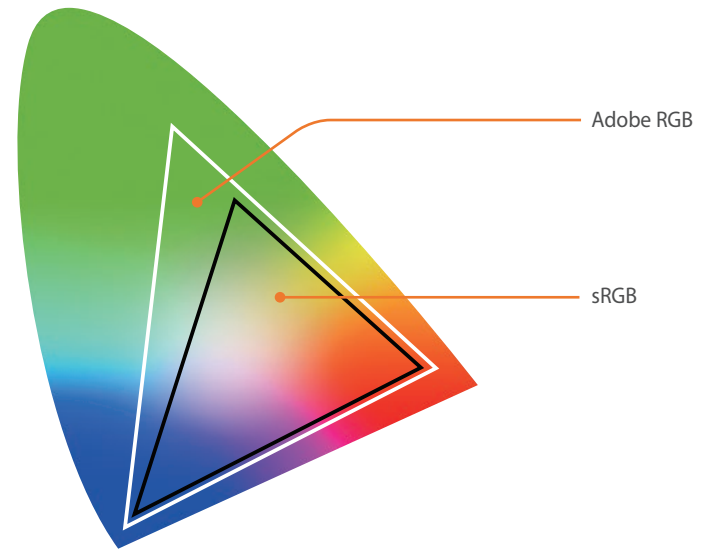

When the color space is set to Adobe RGB, photos will be saved as "\_SAMXXXX.JPG".



## Distortion Correct

You can correct distortion that can be caused by lenses.

## User Display

You can add or remove shooting information from the display.

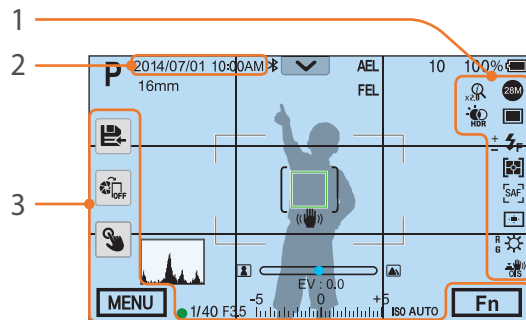

No.	Description
1	<b>Icons</b> Set to display icons on the right in Shooting mode.
2	<b>Date &amp; Time</b> Set to display the date and time.
3	<b>Button</b> Set to display touch icons on the left and the bottom in Shooting mode.

## Grid Line

Select a guide to help you compose a scene.

\* Default

Option	Description
<b>Off*</b>	Disable grid lines.
<b>4 X 4</b>	Set a 4 X 4 grid.
<b>3 X 3</b>	Set a 3 X 3 grid.
<b>Cross</b>	Set the grid lines as cross hairs.
<b>Diagonal</b>	Set the grid lines to cross diagonally.
<b>Action Safe Area</b>	Display grid lines for the current aspect ratio of a video. This is useful when recording a video to fit on another device's screen or editing a video.
<b>4:3 Safe Area</b>	Display grid lines for a standard TV aspect ratio (4:3). This is useful when recording a video to fit on another device's screen or editing a video.
<b>2.35:1 Safe Area</b>	Display grid lines for the cinemascope ratio (2.35:1). This is useful when recording a video to fit on another device's screen or editing a video.



Grid lines are displayed even while recording a video.

## Center Marker

Set to display a cross-shaped center marker in the center of the screen. The center marker is a standard to set the vertical and horizontal levels. You can set the size of the center marker or apply effects to it.

\* Default

Option	Description
<b>Display</b>	Set to turn the center marker on or off. ( <b>Off*</b> , <b>On</b> )
<b>Size</b>	Set the size of the center marker. ( <b>Large</b> , <b>Normal*</b> )
<b>Transparency</b>	Set to apply a transparency effect to the center marker. ( <b>Off*</b> , <b>On</b> )



The center marker is displayed even while recording a video.

## Key Mapping

You can change the function assigned to the Preview button, the AEL button, the AF start button, the navigation button (custom wheel), the delete button, command dials 1 and 2, the video recording button, or the MOBILE button.

### AEL

Set the function for the AEL button. You can change the function assigned to each button to exposure and focus setting, focus lock, or exposure lock. The AEL and AFL functions save the exposure value or focus area respectively when you press [**AEL**]. The function executed by half-pressing [**Shutter**] varies according to the function assigned to [**AEL**].

\* Default

Option	Description
<b>AEL*</b>	Perform the auto exposure lock function. (Half-pressing [ <b>Shutter</b> ] executes the auto focus lock function.)
<b>AEL Hold</b>	Keep the auto exposure lock function on after shooting. (The exposure remains locked even after you capture a photo.)
<b>AFL</b>	Perform the auto focus lock function. (Half-pressing [ <b>Shutter</b> ] executes the auto exposure lock function.)

\* Default

Option	Description
<b>AFL Hold</b>	Keep the auto focus lock function on after shooting. (The focus remains locked even after you capture a photo.)
<b>AEL + AFL</b>	Perform the auto exposure and focus lock functions together.
<b>AEL+AFL Hold</b>	Keep the auto exposure and focus lock functions on together after shooting. (The exposure and focus remain locked even after you capture a photo.)
<b>FEL</b>	Perform the flash intensity lock function. (p. 121)
<b>FEL Hold</b>	Keep the flash intensity lock function on after shooting. (The intensity remains locked even after you capture a photo.) (p. 121)

## AF ON

Set the function for the AF start button.

\* Default

Option	Description
<b>AF Start</b>	Perform the auto focus function.
<b>AF Start + Lock</b>	Perform the auto focus function. Keep the auto exposure and focus lock functions on after shooting. (The exposure and focus remain locked even after you capture a photo.)
<b>Metering &amp; AF start*</b>	Set an optimum exposure by calculating the brightness of the focus area and perform the auto focus function at the same time.
<b>Metering &amp; AF Start + Lock</b>	Set an optimum exposure by calculating the brightness of the focus area and execute the auto focus function at the same time. Keep the auto exposure and focus lock functions on after shooting. (The exposure and focus remain locked even after you capture a photo.)

### Custom Wheel

Select an item to adjust when rotating the navigation button.  
**((None)\*, Shutter Speed, Aperture, ISO, AF Size, EV, Mic Level)**

### Command Dial

Assign the functions that are adjusted when command dials 1 or 2 are rotated.

Mode	Adjustable functions (command dial 1/command dial 2)
<b>Program</b>	Program Shift/Program Shift* Program Shift/EV Program Shift/ISO EV/Program Shift ISO/Program Shift
<b>Aperture Priority</b>	Aperture/Aperture* Aperture/EV Aperture/ISO EV/Aperture ISO/Aperture

\* Default

Mode	Adjustable functions (command dial 1/command dial 2)
<b>Shutter Priority</b>	Shutter Speed/Shutter Speed* Shutter Speed/EV Shutter Speed/ISO EV/Shutter Speed ISO/Shutter Speed
<b>Manual</b>	Shutter Speed/Aperture* Aperture/Shutter Speed

\* Default

### Command Dial Direction

Set the order that command dials 1 and 2 change values. Command dials only operate in reverse direction when you are adjusting the aperture value and shutter speed. In other situations, the command dials operate normally. **(Normal\*, Reverse)**

### Video Recording / MOBILE

Set or switch the functions assigned to the video recording button and the MOBILE button.

\* Default

Option	Description
<b>Video Recording/ MOBILE*</b>	Each button performs its original function.
<b>MOBILE/Video Recording</b>	Set the Wi-Fi function to the video recording button and the video recording function to the MOBILE button.

### AF ON / AEL

Set or switch the functions assigned to the AF ON button and the AEL button.

\* Default

Option	Description
<b>AF ON/AEL*</b>	Each button performs its original function.
<b>AEL/AF ON</b>	Set the AEL function to the AF ON button and the AF ON function to the AEL button.

### Preview button/Navigation button/Delete button

Set the function for each button.

\* Default

Option	Description
<b>Preview (Optical Preview*)</b>	<ul style="list-style-type: none"> <li>• <b>(None):</b> Do not assign any function to the button.</li> <li>• <b>AF Mode:</b> Select a focusing method.</li> <li>• <b>AF Area:</b> Select an auto focus area.</li> <li>• <b>White Balance:</b> Set a White Balance option (light source) that affects the color of a photo.</li> <li>• <b>ISO:</b> Set the sensitivity of the camera to light.</li> </ul>
<b>Custom ◀ Key (AF Area*)</b>	<ul style="list-style-type: none"> <li>• <b>Metering:</b> Select the way in which camera measures the quantity of light.</li> <li>• <b>Touch Operation:</b> Set to enable touch operation in Shooting mode.</li> <li>• <b>Dynamic Range:</b> Select an option to correct brightness differences caused by shadows in the photo.</li> <li>• <b>Minimum Shutter Speed:</b> Set the shutter speed not to be slower than the selected speed.</li> </ul>
<b>Custom ▶ Key (Movie STBY*)</b>	<ul style="list-style-type: none"> <li>• <b>Auto ISO Range:</b> Set the maximum ISO value under which each EV step is chosen when you set the ISO to Auto.</li> <li>• <b>Picture Wizard:</b> Apply effects to a photo depending on the theme.</li> <li>• <b>Smart Filter:</b> Apply special effects to a photo.</li> <li>• <b>Drive Settings:</b> Set Continuous, Timer, or Bracket shooting options.</li> <li>• <b>Flash:</b> Set flash options according to the shooting conditions.</li> </ul>
<b>Custom ▼ Key (Picture Wizard*)</b>	<ul style="list-style-type: none"> <li>• <b>intelli-Zoom:</b> Zoom in on a subject with less degradation of photo quality than the Digital zoom.</li> <li>• <b>MF Assist:</b> Set the assist function that helps easier focusing when you rotate the focus ring manually.</li> <li>• <b>Framing Mode:</b> Set the display brightness to remain constant, regardless of the aperture value or shutter speed.</li> <li>• <b>Grid Line:</b> Select a guide to help you compose a scene.</li> <li>• <b>Movie STBY:</b> Switch to Video recording standby mode.</li> </ul>
<b>Delete (Drive Settings*)</b>	<ul style="list-style-type: none"> <li>• <b>Optical Preview:</b> Perform the Depth of Field Preview function for the current aperture value.</li> <li>• <b>One Touch WB:</b> Perform the Custom White Balance function.</li> <li>• <b>One Touch RAW +:</b> Save a file in the RAW+JPEG format. To save a file in JPEG format, press the button again.</li> <li>• <b>One Touch HDR:</b> Enable or disable the HDR Dynamic Range option.</li> </ul>

## iFn Customizing

You can select options that can be adjusted when you press [**i-Function**] on an i-Function lens.

Option	Description
<b>Aperture</b>	Set to adjust the aperture value.
<b>Shutter Speed</b>	Set to adjust the shutter speed.
<b>EV</b>	Set to adjust the exposure value.
<b>ISO</b>	Set to adjust ISO sensitivity.
<b>White Balance</b>	Set to adjust the White Balance.
<b>intelli-Zoom</b>	Set to adjust the zoom scale.

## Lens Button Speed Settings

Set the zoom speed for the Power Zoom lens' buttons at either fast, medium, or slow speed. At fast speed, zoom noise increases and can be recorded in videos. This function is available only when you attach the Power Zoom lens.

## Touch Operation

Set to enable touch operation in Shooting mode.

\* Default

Option	Description
<b>Off</b>	Disable touch operations in Shooting mode. (You can use touch operations in other situations.)
<b>On*</b>	Enable touch operations in Shooting mode.

## AF Lamp

Select the AF lamp brightness. When shooting in dark places, turn the AF lamp on to improve the operation of the auto focus. The Auto Focus functions more accurately in dark places when the AF lamp is on. The AF lamp emits the light in irregular vertical patterns. (**Off**, **High Brightness\***, **Medium Brightness**, **Low Brightness**)

## E-Shutter

\* Default

Option	Description
Off*	Set to use the mechanical shutter.
On	Set to use the electronic shutter curtain first and the mechanical curtain second.



- This feature is available only when you attach a Samsung lens using a Samsung NX mount.
- When you use a large diameter lens and a fast shutter speed, a “bokeh” effect (an aesthetic blur in out-of-focus areas) may be affected by the subject and the shooting conditions. To make the bokeh effect appear correctly, set the **E-Shutter** to **Off**.
- When you change the E-Shutter settings, the first curtain of the shutter is adjusted and you will hear a noise as the shutter adjusts. This is normal when preparing the camera to operate the E-Shutter.
- This feature is not available when you attach the external flash (SEF-580A).

## MobileLink/NFC Image Size

Set the size of photos to transfer to a smart phone using the MobileLink or NFC function.

\* Default

Option	Description
Resize to 2M or lower	If a photo's size is larger than 3M, the camera will transfer it after resizing it to 2M or lower.
Original*	The photo will be transferred in its original size.





# Setting

Learn to configure your camera's settings.

To set Setting options,



In Shooting or Playback mode, press [MENU] → ⚙ → an option.

Item	Description
	* Default
Sound	<ul style="list-style-type: none"> <li>• <b>System Volume:</b> Set the sound volume or turn all sound off entirely. (<b>Off, Low, Medium*</b>, <b>High</b>)</li> </ul> <div style="border: 1px solid #ccc; padding: 5px; margin-top: 5px;">  Even if the system volume is turned off, the camera emits the sound while playing a video.         </div>
	<ul style="list-style-type: none"> <li>• <b>AF Sound:</b> Set the sound the camera emits when you half-press the shutter button on or off. (<b>Off, On*</b>)</li> <li>• <b>Button Sound:</b> Set the sound the camera emits when you press the buttons or touch the screen on or off. (<b>Off, On*</b>)</li> </ul>
	<div style="border: 1px solid #ccc; padding: 5px; margin-top: 5px;">  <ul style="list-style-type: none"> <li>• The camera emits a sound only when the shutter speed is longer than 0.5 second.</li> <li>• This option may not be available in Smart mode.</li> </ul> </div>
Quick View	Set the Quick View time length—the amount of time the camera displays a photo immediately after you capture it. Select <b>Hold+Focus Zoom</b> to display the image after shooting with the focus area enlarged. ( <b>Off*</b> , <b>Hold+Focus Zoom, Hold, 1 sec, 3 sec, 5 sec</b> )

Item	Description
Display Adjust	Adjust the display brightness, auto brightness setting, display color, or level gauge. <ul style="list-style-type: none"> <li>• <b>Display Brightness:</b> You can adjust the display brightness manually.</li> <li>• <b>Auto Brightness:</b> Turn auto brightness on or off. (<b>Off, On*</b>)</li> <li>• <b>Display Color:</b> You can adjust the display color manually.</li> <li>• <b>Horizontal Calibration:</b> Calibrate the level gauge. If the level gauge is not level, position the camera on the level surface, and then follow the on-screen instructions.</li> </ul>
	<div style="border: 1px solid #ccc; padding: 5px; margin-top: 5px;">  <ul style="list-style-type: none"> <li>• You cannot access the <b>Horizontal Calibration</b> option in Playback mode.</li> <li>• You cannot calibrate the level gauge in portrait orientation.</li> </ul> </div>
Auto Display Off	Set the display off time. The display turns off if you do not use the camera for the time you set. ( <b>Off, 30 sec*</b> , <b>1 min, 3 min, 5 min, 10 min</b> )

\* Default

\* Default

Item	Description
Power Save	<p>Set power shut off time. The camera shuts off if you do not use it for the time you set. <b>(30 sec, 1 min*, 3 min, 5 min, 10 min, 30 min)</b></p> <div style="border: 1px solid #ccc; padding: 5px; background-color: #f9f9f9;">  <ul style="list-style-type: none"> <li>The camera retains the power-off time setting even if you replace the battery.</li> <li>Power Save may not work if the camera is connected to a computer or a TV or playing a slide show or a movie.</li> <li>Power Save may not work when the camera is connected to a smart phone and Pro Suggest Market is in use.</li> </ul> </div>
Help Guide Display	<ul style="list-style-type: none"> <li><b>Mode Help Guide:</b> Set to display help text about the selected mode when changing shooting modes. <b>(Off*, On)</b></li> <li><b>Function Help Guide:</b> Set to display help text about menus and functions. <b>(Off*, On)</b></li> </ul> <div style="border: 1px solid #ccc; padding: 5px; background-color: #f9f9f9;">  Press [ ] to hide the help text.         </div>
Language	Set a language the camera shows on the display.
Date and Time	Set date, time, date format, and time zone. <b>(Time Zone, Date Settings, Time Settings, Date Type, Time Type)</b>

\* Default

Item	Description
Video Out	<p>Set the video signal output to the appropriate system for your country when connecting the camera to an external video device, such as an HDMI-supported TV.</p> <ul style="list-style-type: none"> <li><b>NTSC:</b> USA, Canada, Japan, Korea, Taiwan, Mexico, etc.</li> <li><b>PAL</b> (Supports only PAL B, D, G, H, or I): Australia, Austria, Belgium, China, Denmark, Finland, France, Germany, England, Italy, Kuwait, Malaysia, New Zealand, Singapore, Spain, Sweden, Switzerland, Thailand, Norway, etc.</li> </ul>
Anynet+ (HDMI-CEC)	<p>When you connect the camera to an HDMI-supported TV that supports Anynet+ (HDMI-CEC), you can control the playback functions of the camera with the TV remote control.</p> <ul style="list-style-type: none"> <li><b>Off:</b> You cannot control the play function of camera with the TV remote control.</li> <li><b>On*:</b> You can control the play function of camera with the TV remote control.</li> </ul>
HDMI Output	<p>When you connect the camera to an HDMI-supported TV with an HDMI cable, you can change the resolution of the image.</p> <ul style="list-style-type: none"> <li><b>NTSC: Auto*, 4096x2160p, 4096x2160p Clean out, 3840x2160p, 3840x2160p Clean out, 1920x1080p, 1280x720p, 720x480p, 720x576p</b> (activates only when PAL is selected)</li> </ul> <div style="border: 1px solid #ccc; padding: 5px; background-color: #f9f9f9;">  If you select <b>4096x2160p Clean out</b> or <b>3840x2160p Clean out</b>, only a video without the camera's on-screen information is displayed on the TV.         </div>

\* Default

Item	Description
USB Connection	<p>Set the action to perform when the camera is connected to a computer via USB.</p> <ul style="list-style-type: none"> <li>• <b>Mass Storage*</b>: Set the camera to be recognized by the computer as a removable disk.</li> <li>• <b>Remote Access</b>: Enable the camera to be controlled by software (Remote Studio) on a computer that is connected to the camera via USB.</li> </ul>
File Name	<p>Set the method of creating file names.</p> <ul style="list-style-type: none"> <li>• <b>Standard*</b>: SAM_XXXX.JPG (sRGB)/_SAMXXXX.JPG (Adobe RGB)</li> <li>• <b>Date</b>: <ul style="list-style-type: none"> <li>- sRGB files - MMDDXXXX.JPG. For example, for a photo captured on Jan. 01, the file name would be 0101XXXX.jpg.</li> <li>- Adobe RGB files - _MDDXXXX.JPG for the months Jan through Sept. For the months Oct through Dec, the month number is replaced by the letters A (Oct.), B (Nov.), and C (Dec.).</li> </ul> </li> </ul> <p>For example, for a photo captured on Feb. 03, the file name would be _203XXXX.jpg. For a photo captured on Oct. 05, the file name would be _A05XXXX.jpg.</p>



\* Default

Item	Description
File Number	<p>Set the method of numbering files and folders.</p> <ul style="list-style-type: none"> <li>• <b>Reset</b>: After using the reset function, the next file name is started at 0001.</li> <li>• <b>Series*</b>: New file numbers continue the existing number sequence, even if you have installed a new memory card, formatted the card, or deleted all photos.</li> </ul> <div style="background-color: #f0f0f0; padding: 10px; border: 1px solid #ccc;">  <ul style="list-style-type: none"> <li>• The first folder name is 100PHOTO. If you have selected the sRGB color space and Standard file naming, the first file name is SAM_0001.</li> <li>• File name numbers are increased by 1 from SAM_0001 to SAM_9999.</li> <li>• Folder numbers are increased by 1 from 100PHOTO to 999PHOTO.</li> <li>• The maximum number of files that can be saved in one folder is 9,999.</li> <li>• File numbers are assigned according to DCF (Design rule for Camera File system) specifications.</li> <li>• If you change a file name (for example, on a computer), the camera will not be able to play the file.</li> </ul> </div>
Folder Type	<p>Set the type of folder.</p> <ul style="list-style-type: none"> <li>• <b>Standard*</b>: XXXPHOTO</li> <li>• <b>Date</b>: XXX_MMDD</li> </ul>

\* Default

Item	Description
<b>Format</b>	<p>Format the memory card. Formatting deletes all existing files including protected files. <b>(No*, Yes)</b></p> <div style="border: 1px solid #ccc; background-color: #f9f9f9; padding: 5px; margin-top: 10px;">  <p>Errors can occur if you use a memory card formatted by another brand of camera, a memory card reader, or a computer. Please format memory cards in the camera before using them to capture photos.</p> </div>
<b>Bluetooth</b>	<p>Set to connect your camera to a smart phone automatically via the Bluetooth feature. If the devices have previously been connected and you launch Samsung Camera Manager on the smart phone, they will connect via Bluetooth automatically. <b>(Off*, On)</b></p>
<b>Wi-Fi network</b>	<p>Set to connect to a Wi-Fi network. <b>(Off*, On)</b></p>
<b>My Smartphone</b>	<p>View the model name and connection status of the connected smart phone. You can also edit or delete the registered smart phone.</p>
<b>Bluetooth Auto Time Set</b>	<p>Set to sync the camera's date and time with the smart phone when connecting the camera to a smart phone via Bluetooth. <b>(Off*, On)</b></p>

\* Default

Item	Description
<b>Wi-Fi Privacy lock</b>	<p>Set to require a PIN when connecting the camera and a smart phone.</p> <ul style="list-style-type: none"> <li>• <b>PIN</b>: Enter a PIN before connecting.</li> <li>• <b>None*</b>: Allow a connection without requiring a PIN.</li> </ul> <div style="border: 1px solid #ccc; background-color: #f9f9f9; padding: 5px; margin-top: 10px;">  <ul style="list-style-type: none"> <li>• Connections will automatically be made without requiring a PIN when using the NFC function.</li> <li>• PINs are automatically generated and renewed only when you reset the camera settings or update the firmware.</li> <li>• If you have previously connected your camera to a smart phone via a PIN, they will connect automatically.</li> </ul> </div>
<b>Dual-band Mobile AP</b>	<p>Set a frequency for using the camera as an AP for the Quick Transfer, MobileLink, or Remote Viewfinder features. <b>(2.4 GHz*, 5 GHz)</b></p> <div style="border: 1px solid #ccc; background-color: #f9f9f9; padding: 5px; margin-top: 10px;">  <p>If you use the camera in a country other than the one where it was purchased, the 5 GHz Wi-Fi feature may not function properly, due to differences in radio frequencies. In this case, use the 2.4 GHz Wi-Fi feature instead.</p> </div>

\* Default

Item	Description
Sensor Cleaning	<ul style="list-style-type: none"> <li>• <b>Sensor Cleaning:</b> Remove dust from the sensor.</li> <li>• <b>Start-Up Action:</b> When on, the camera performs sensor cleaning each time you turn it on. (<b>Off*</b>, <b>On</b>)</li> <li>• <b>Shut down Action:</b> When on, the camera performs sensor cleaning each time you turn it off. (<b>Off*</b>, <b>On</b>)</li> </ul> <div style="border: 1px solid #ccc; padding: 5px; margin-top: 10px;">  <p>As this product uses interchangeable lenses, the sensor can get dust on it when you change lenses. This can lead to dust particles appearing in the photos you capture. We recommend that you do not change lenses when you are in a particularly dusty area. Also, make sure to attach the lens cap to the lens when not using it.</p> </div>
Battery Selection	<p>Set the priority of using and charging the internal battery (in the camera) and external battery (in the vertical grip) when using a vertical grip. This function is supported only when the vertical grip is attached.</p> <ul style="list-style-type: none"> <li>• <b>Auto*:</b> Use the external battery (in the vertical grip) first and charge the internal battery (in the camera) first.</li> <li>• <b>Internal:</b> Use and charge the internal battery (in the camera) first. Use the external battery (in the vertical grip) after the internal battery (in the camera) is discharged.</li> <li>• <b>External:</b> Use and charge the external battery (in the vertical grip) first. Use the internal battery (in the camera) after the external battery (in the vertical grip) is discharged.</li> </ul>

\* Default

Item	Description
Reset	<ul style="list-style-type: none"> <li>• <b>Camera Menu*:</b> Return the setup menu and shooting options to the factory defaults.</li> <li>• <b>Key Mapping:</b> Return the custom button functions to the factory defaults.</li> <li>• <b>C1/C2 Mode:</b> Return the Custom 1 and Custom 2 mode settings to the factory defaults.</li> <li>• <b>Bluetooth/Wi-Fi:</b> Return the connection history, ID, and password of the Bluetooth and Wi-Fi functions to the factory defaults.</li> <li>• <b>All:</b> Return all settings to the factory defaults. (Date, time, language, and video output settings will not change.)</li> </ul>

\* Default

Item	Description
<p><b>Device Information</b></p>	<p>View the firmware version of the body and the lens, the Wi-Fi MAC address, Bluetooth MAC address, and network certification number, or update the firmware.</p> <ul style="list-style-type: none"> <li>• <b>Software Update:</b> Update the firmware of the camera body or lens, or download the firmware via Wi-Fi. (<b>Body Firmware, Lens Firmware, Download via Wi-Fi</b>)</li> </ul> <div style="border: 1px solid gray; padding: 10px; background-color: #f0f0f0;">  <ul style="list-style-type: none"> <li>• You can update the firmware by connecting the camera to a computer and starting i-Launcher. For more details, refer to page 216.</li> <li>• You cannot run a firmware update without a fully charged battery. Recharge the battery fully before running a firmware update.</li> <li>• If you update the firmware, user settings and values will be reset. (Date, time, language, and video out will not change.)</li> <li>• Do not turn the camera off while the update is in progress.</li> <li>• Remaining storage on the memory card must be more than 1 GB to update the firmware via Wi-Fi.</li> <li>• Updating firmware via Wi-Fi may not be stable depending on the quality of the network connection.</li> </ul> </div>
<p><b>Open Source License</b></p>	<p>View open source licenses.</p>





## Chapter 6

# Appendix

---

Get information about error messages, camera maintenance, using programs on a computer, firmware updates, troubleshooting tips, specifications, and glossary terms.

# Error messages

When the following error messages appear, try these remedies.

Error messages	Suggested remedies
<b>Lens is locked</b>	The lens is locked. Rotate the lens counter-clockwise until you hear a click. (p. 59)
<b>Card Error</b>	<ul style="list-style-type: none"> <li>• Turn off the camera, and then turn it on again.</li> <li>• Remove the memory card and insert it again.</li> <li>• Format the memory card.</li> </ul>
<b>Low Battery</b>	Insert a charged battery or recharge the battery.
<b>No Image File</b>	Capture photos or insert a memory card that contains photos.
<b>File Error</b>	Delete the damaged file or contact a service center.
<b>Memory Full</b>	Delete unnecessary files or insert a new memory card.
<b>Card Locked</b>	You can lock SD, SDHC, or SDXC cards to prevent files from being deleted. Unlock the card when shooting. (p. 203)

Error messages	Suggested remedies
<b>Unable to capture a photo because folder and file number on the memory card reached the maximum values. Reset the folder number?</b>	File names do not match the DCF standard. Follow the on-screen instructions to reset the folder number.
<b>Error 00</b>	Turn off your camera and remount the lens. If the message still appears, contact a service center.
<b>Error 01/02</b>	Turn off your camera, remove the battery, and insert again. If the message still appears, contact a service center.



# Maintaining the camera

## Cleaning the camera

### Camera lens and display

Use a brush to remove dust and wipe the lens gently with a soft cloth. If any dust remains, apply lens cleaning liquid to a piece of lens cleaning paper and wipe gently.

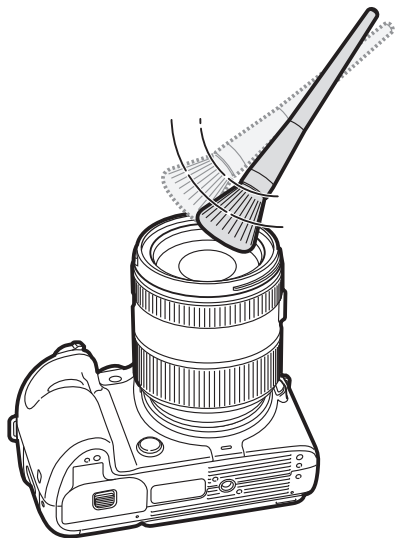

### Image sensor

Depending on different shooting conditions, dust may appear in photos because the image sensor is exposed to the external environment. This problem is normal, and the exposure to dust occurs in everyday use of the camera. You can remove dust from the sensor by operating the sensor cleaning function. (p. 196) If dust remains after cleaning the sensor, contact a service center. Do not insert the blower into the opening of the lens mount.

### Camera body

Wipe gently with a soft, dry cloth.



Never use benzene, thinners, or alcohol to clean the camera. These solutions can damage the camera or cause it to malfunction.

## Using or storing the camera

### Inappropriate places to use or store the camera

- Avoid exposing the camera to very cold or very hot temperatures.
- Avoid using your camera in areas with extremely high humidity, or where the humidity changes drastically.
- Avoid exposing the camera to direct sunlight and storing it in hot, poorly ventilated areas, such as in a car during summer time.
- Protect your camera and the display from impact, rough handling, and excessive vibration to avoid serious damage.
- Avoid using or storing your camera in dusty, dirty, humid, or poorly ventilated areas to prevent damage to moving parts and internal components.
- Do not use your camera near fuels, combustibles, or flammable chemicals. Do not store or carry flammable liquids, gases, or explosive materials in the same compartment as the camera or its accessories.
- Do not store the camera where there are mothballs.

### Using on beaches or shores

- Protect your camera from sand and dirt when you use it on beaches or in other similar areas.
- Your camera is not waterproof. Do not handle the battery, adapter, or memory card with wet hands. Operating the camera with wet hands may cause damage to your camera.

### Storing for extended period of time

- When you store the camera for an extended period, place it in a sealed container with an absorbent material, such as silica gel.
- Over time, unused batteries will discharge and must be recharged before use.
- The present date and time must be re-entered if the camera is turned on after the camera and battery have been separated for a prolonged period.

### Using the camera with caution in the humid environments

When you move the camera from a cold environment to a warm one, condensation can form on the lens or internal components of the camera. In this situation, turn off the camera and wait for at least 1 hour. If condensation forms on the memory card, remove the memory card from the camera and wait until all moisture has evaporated before reinserting it.

### Other precautions

- Do not swing your camera by the strap. This may cause injury to yourself or others or damage to your camera.
  - Do not paint your camera, as paint can clog moving parts and prevent proper operation.
  - Turn off the camera when not using it.
  - Your camera consists of delicate parts. Avoid impacts to the camera.
  - Protect the display from damage by keeping it in the case when not in use. Protect the camera from scratches by keeping it away from sand, sharp objects, or loose change.
  - Do not use the camera if the screen is cracked or broken. Broken glass or acrylic could cause injury to your hands and face. Take the camera to a Samsung service center to have it repaired.
  - Never place cameras, batteries, chargers, or accessories near, on, or in heating devices, such as microwave ovens, stoves, or radiators. Heat can deform or overheat these devices, which can cause a fire or explosion.
- Do not expose the lens to direct sunlight, as this may discolor the image sensor or cause it to malfunction.
  - Protect your lens from fingerprints and scratches. Clean your lens with a soft, clean, debris-free lens cloth.
  - The camera may turn off if impacted from the outside. This is to protect the memory card. Turn on the camera to use it again.
  - While you use the camera, it may heat up. This is normal and should not affect your camera's lifespan or performance.
  - When you use the camera in low temperatures, it may take some time to turn on, the color of the display may be changed temporarily, or after-images may appear. These conditions are not malfunctions and they will correct themselves when the camera is returned to milder temperatures.
  - Paint or metal on the outside of the camera may cause allergies, itchy skin, eczema, or swelling for people with sensitive skin. If you experience any of these symptoms, stop using the camera immediately and consult a doctor.
  - Do not insert foreign objects into any of your camera's compartments, slots, or access points. Damage due to improper use may not be covered by your warranty.
  - Do not allow unqualified personnel to service the camera or attempt to service the camera yourself. Any damage that results from unqualified service is not covered by your warranty.

## About memory cards

### Supported memory cards

This product supports SD (Secure Digital), SDHC (Secure Digital High Capacity), SDXC (Secure Digital eXtended Capacity), microSD, microSDHC, or microSDXC memory cards.

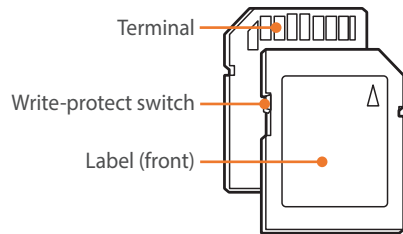

You can prevent files from being deleted by using the write-protect switch on an SD, SDHC, or SDXC card. Slide the switch down to lock or slide it up to unlock. Unlock the card when capturing photos and videos.

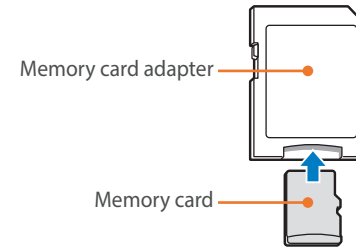

To use micro memory cards with this product, a PC, or a memory card reader, insert the card into an adapter.

### Memory card capacity

The memory capacity may differ depending on the type of scenes you shoot and the shooting conditions. These capacities are based on a 4 GB SD card.

	Size	Quality						
		Super Fine	Fine	Normal	RAW	RAW + S.Fine	RAW + Fine	RAW + Normal
Photo	28M (6480X4320)	256	471	809	84	63	71	76
	13.9M (4560X3040)	475	815	1,270	-	73	79	81
	7.1M (3264X2176)	801	1,253	1,744	-	80	83	84
	3M (2112X1408)	1,379	1,863	2,259	-	84	86	86
	23.6M (6480X3648)	299	542	911	-	66	73	77
	11.9M (4608X2592)	537	905	1,376	-	75	80	82
	6.2M (3328X1872)	879	1,346	1,832	-	81	83	85
	2.4M (2048X1152)	1,545	2,008	2,363	-	85	86	87
	18.7M (4320X4320)	368	653	1,064	-	70	76	79
	9.5M (3088X3088)	642	1,050	1,537	-	77	81	83
	4.7M (2160X2160)	1,064	1,553	2,015	-	82	84	86
2M (1408X1408)	1,668	2,109	2,431	-	85	86	87	

Size		Quality		
		Pro	HQ	Normal
Video	4096X2160 (24p/NTSC, PAL)	Approx. 7' 19"	Approx. 14' 35"	Approx. 18' 15"
	3840X2160 (30p/NTSC, 25p/PAL)	Approx. 6' 34"	Approx. 13' 06"	Approx. 16' 22"
	3840X2160 (24p/NTSC, PAL)	Approx. 7' 30"	Approx. 14' 57"	Approx. 18' 42"
	3840X2160 (23.98p/NTSC)	Approx. 7' 30"	Approx. 14' 57"	Approx. 18' 42"
	1920X1080 (60p/NTSC, 50p/PAL)	Approx. 13' 07"	Approx. 30' 27"	Approx. 38' 07"
	1920X1080 (30p/NTSC, 25p/PAL)	Approx. 29'	Approx. 57' 02"	Approx. 71' 27"
	1920X1080 (24p/NTSC, PAL)	Approx. 33' 05"	Approx. 64' 57"	Approx. 81' 23"
	1920X1080 (23.98p/NTSC)	Approx. 33' 05"	Approx. 64' 57"	Approx. 81' 23"
	1280X720 (60p/NTSC, 50p/PAL)	-	Approx. 64' 57"	Approx. 81' 23"
	1280X720 (30p/NTSC, 25p/PAL)	-	Approx. 111' 12"	Approx. 139' 34"
	640X480 (60p/NTSC, 50p/PAL)	-	Approx. 183' 56"	Approx. 231' 30"
	640X480 (30p/NTSC, 25p/PAL)	-	Approx. 302' 42"	Approx. 382' 36"
	640X480, MJPEG (25p/PAL)	-	Approx. 40' 36"	Approx. 49' 22"
	640X480, MJPEG (30p/NTSC)	-	Approx. 34' 29"	Approx. 42' 06"

- The figures above are measured without using the zoom function.
- Available recording time may vary if you use the zoom function.
- Several videos were recorded in succession to determine the total recording time.
- The maximum recording time is 29 minutes and 59 seconds per file.

### Cautions when using memory cards

- Avoid exposing memory cards to very cold or very hot temperatures (below 0 °C/32 °F or above 40 °C/104 °F). Extreme temperatures can cause memory cards to malfunction.
- Insert a memory card in the correct direction. Inserting a memory card in the wrong direction may damage your camera and memory card.
- Do not use memory cards that have been formatted by other cameras or by a computer. Reformat the memory card with your camera.
- Turn off the camera when you insert or remove the memory card.
- Do not remove the memory card or turn off your camera while the lamp is blinking, as this may damage your data.
- When the lifespan of a memory card has expired, you cannot store any more photos on the card. Use a new memory card.
- Do not bend, drop, or subject memory cards to heavy impact or pressure.
- Avoid using or storing memory cards near strong magnetic fields.
- Avoid using or storing memory cards in very hot, very humid, or corrosive environments.
- Prevent memory cards from making contact with liquids, dirt, or foreign substances. If dirty, wipe the memory card clean with a soft cloth before you insert the memory card into your camera.
- Do not allow liquids, dirt, or foreign substances to come in contact with memory cards or the memory card slot. Doing so may cause memory cards or the camera to malfunction.
- When you carry a memory card, use a case to protect the card from electrostatic discharges.
- Transfer important data to other media, such as a hard disk, CD, or DVD.
- When you use the camera for an extended period, the memory card may become warm. This is normal and does not indicate a malfunction.
- Use a memory card that meets the standard requirements.



The manufacturer is not responsible for any loss of data.

## About the battery

Use only Samsung-approved batteries.

### Battery specifications

Item	Description
Model	BP1900
Type	Lithium-ion battery
Cell capacity	1,860 mAh
Voltage	7.2 V
Charging time* (When the battery is completely discharged.)	Approx. 170 min. (Approx. 340 min. when the vertical grip is connected)

\*The figures above are based on using the provided USB cable and AC adaptor. Charging the battery by connecting it to a computer may take longer.



**Personal injury or death can occur if the battery is handled carelessly or improperly. For your safety, follow these instructions for proper battery handling:**

- The battery can ignite or explode if not handled properly. If you notice any deformities, cracks, or other abnormalities in the battery, immediately discontinue use of the battery and contact your manufacturer.
- Use only authentic, manufacturer-recommended battery chargers and charge the battery only by the method described in this user manual.
- Do not place the battery near heating devices or expose to excessively warm environments, such as the inside of an enclosed car in the summertime.
- Do not place the battery in a microwave oven.
- Avoid storing or using the battery in hot, humid places, such as spas or shower enclosures.

- Do not rest the camera on flammable surfaces, such as bedding, carpets, or electric blankets for a prolonged period.
- When the camera is switched on, do not leave it in any confined space for a prolonged period.
- Do not allow battery terminals to come in contact with metallic objects, such as necklaces, coins, keys, or watches.
- Use only authentic, manufacturer-recommended, Lithium-ion replacement batteries.
- Do not disassemble the battery or puncture it with any sharp object.
- Avoid exposing the battery to high pressure or crushing forces.
- Avoid exposing the battery to major impacts, such as dropping it from high places.
- Do not expose the battery to temperatures of 60 °C (140 °F) or above.
- Do not allow the battery to come in contact with moisture or liquids.
- Do not expose the battery to sources of excessive heat such as direct sunshine or fire.

### Disposal guidelines

- Dispose of the battery with care.
- Do not dispose of the battery in a fire.
- Disposal regulations may differ by country or region. Dispose of the battery in accordance with all local and federal regulations.

### Guidelines for charging the battery

Charge the battery only by the method described in this user manual. The battery can ignite or explode if not charged properly.



### Battery life

Shooting mode	Average time / Number of photos
Photos	Approx. 250 min./Approx. 500 photos
Videos	Approx. 110 min. (Record videos at 3840X2160 (30p))

- The figures above are based on CIPA test standards. Your results may differ depending on your actual usage.
- Available shooting time differs depending on background, shooting interval, and use conditions.
- Several videos were recorded in succession to determine the total recording time.

### Low battery message

When the battery has fully discharged, the battery icon will turn red and the “**Low Battery**” message will appear.

### Notes about using the battery

- Avoid exposing batteries to very cold or very hot temperatures (below 0 °C/32 °F or above 40 °C/104 °F). Extreme temperatures can reduce the charging capacity of your batteries.
- When you use the camera for an extended period, the area around the battery chamber may become warm. This does not affect the normal use of the camera.
- Do not pull the power supply cord to disconnect the plug from the power outlet, as this may cause a fire or electric shock.
- In temperatures below 0 °C/32 °F, battery capacity and battery life may decrease.
- Battery capacity may decrease in low temperatures, but will return to normal in milder temperatures.
- Remove the batteries from your camera when storing it for an extended period. Installed batteries may leak or corrode over time and cause serious damage to your camera. Storing the camera for extended periods with the battery installed causes the battery to discharge. You may not be able to recharge a fully discharged battery.
- When you do not use the camera for an extended period (3 months or more), check the battery and recharge it regularly. If you let the battery discharge continually, its capacity and life may decrease, which can lead to a malfunction, fire, or explosion.

### Battery precautions

#### Protect batteries, chargers, and memory cards from damage.

Prevent batteries from making contact with metal objects, as this can create a connection between the + and – terminals of your battery and lead to temporary or permanent battery damage and may cause a fire or electric shock.

### Notes about charging the battery

- If the status lamp is off, ensure that the battery is inserted correctly.
- If the camera is on while the battery is charging, the battery may not fully charge. Turn off the camera before charging the battery.
- Do not use your camera when you are charging the battery. This may cause a fire or electric shock.
- Do not pull the power supply cord to disconnect the plug from the power outlet, as this may cause a fire or electric shock.
- Let the battery charge for at least 10 minutes before turning on the camera.
- If you connect the camera to an external power source when the battery is depleted, using high energy-consuming functions will cause the camera to turn off. To use the camera normally, recharge the battery.
- If you reconnect the power cable when the battery is fully charged, the status lamp turns on for approximately 30 minutes.
- Using the flash or recording videos depletes the battery quickly. Charge the battery fully before using the camera.
- If the status lamp blinks in red, reconnect the cable, or remove the battery and insert it again.
- If you charge the battery when the cable is overheated or the temperature is too high, the status lamp may blink in red. Charging will start when the battery cools down.
- Overcharging batteries may shorten battery life. After charging is finished, disconnect the cable from your camera.
- Do not bend or place heavy objects on the AC cable. Doing so may damage the cable.

### Notes about charging with a computer connected

- Use only the provided USB cable.
- The battery may not charge when:
  - You use a USB hub.
  - Other USB devices are connected to your computer.
  - You connect the cable to the port on the front side of your computer.
  - The USB port of your computer does not support the power output standard (5 V, 500 mA).

### Handle and dispose of batteries and chargers with care

- Never dispose of batteries in a fire. Follow all local regulations when you dispose of used batteries.
- Never place batteries or cameras on or in heating devices, such as microwave ovens, stoves, or radiators. Batteries may explode when they are overheated.



# Using programs on a PC

You can view and edit files using the provided programs. You can also send the files to a PC wirelessly.

## Installing i-Launcher or i-Launcher Web

- 1 In Shooting or Playback mode, press [MENU] → ⚙ → **USB Connection** → **Mass Storage**. (p. 194)
- 2 Turn off the camera.
- 3 Connect the camera to the PC with the USB cable.

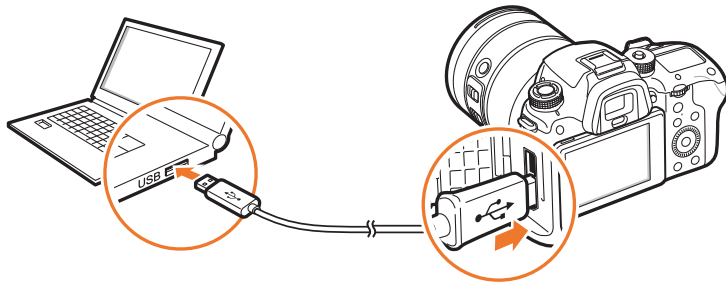

- You must plug the small end of the USB cable into your camera. If the cable is reversed, it may damage your files. The manufacturer is not responsible for any loss of data.
- If you try to plug the USB cable into the HDMI port, the camera may not work properly.
- When using a USB 2.0 cable, plug the USB cable into the lower part of the USB port. If the plug connectors are forced, the device may be damaged. The manufacturer is not responsible for any loss of data.

- 4 Turn on the camera.
- 5 Install i-Launcher on the PC.

OS	How to Install
Windows	<p>When the pop-up window prompts you to install i-Launcher, select <b>Yes</b>.</p> <ul style="list-style-type: none"> <li>• If the pop-up window does not appear, select <b>My Computer</b> → <b>i-Launcher</b> → <b>iLinker.exe</b>.</li> <li>• If a pop-up window prompting you to run iLinker.exe appears, run it first.</li> <li>• When you connect the camera to a computer with i-Launcher installed, the program will launch automatically.</li> </ul>
Mac	Click <b>Devices</b> → <b>i-Launcher</b> → <b>Mac</b> → <b>iLinker.app</b> .

- 6 Follow the on-screen instructions to install i-Launcher or i-Launcher Web.
  - Available programs may differ depending on your computer's specifications.



Before installing the program, ensure that the PC is connected to a network.

## Requirements for Windows OS

Item	Requirements
CPU	Intel® 3rd Gen. i5 3.4 GHz or higher (or equivalent AMD processor)
RAM	Minimum 2 GB RAM
OS	Windows 7, Windows 8, Windows 8.1
Hard disk capacity	20 GB or more
Web browser	Internet Explorer 10 or later (When i-Launcher Web is turned on)
Others	<ul style="list-style-type: none"> <li>• CD-ROM drive</li> <li>• USB 2.0 port</li> </ul>



- The requirements on the following pages are recommendations only. i-Launcher may not work properly even when the computer meets the requirements, depending on the condition of your computer.
- If your computer does not meet the requirements, videos may not play correctly.



The manufacturer is not responsible for any damage that results from using unqualified computers such as a computer you assembled yourself.

## Requirements for Mac OS

Item	Requirements
OS	Mac OS 10.7 or higher
RAM	Minimum 2 GB RAM
Hard disk capacity	Minimum 7 GB
Web browser	Safari 6 or later (When i-Launcher Web is turned on)
Others	USB 2.0 port, CD-ROM drive

## Using i-Launcher or i-Launcher Web

i-Launcher or i-Launcher Web allows you to update the firmware of the camera or the lens, or download the User Manual. It also allows you to download and install Samsung Movie Converter, Samsung DNG Converter, PC Auto Backup, Power Media Player, and the NX1 SDK reference program.

### Opening i-Launcher

If i-Launcher Web is installed, it is automatically launched when the camera is connected to a PC with the USB cable. If it is not automatically launched, select **Start** → **All Programs** → **Samsung** → **i-Launcher Web** → **Samsung i-Launcher Web** on your computer. Or, click **Applications** → **Samsung** → **i-Launcher\_Start** on your Mac OS computer.

If the PC version of i-Launcher is installed, select **Start** → **All Programs** → **Samsung** → **i-Launcher** → **Samsung i-Launcher** on your computer. Or, click **Applications** → **Samsung** → **i-Launcher** on your Mac OS computer.

### Available programs

Item	Description
<b>Software Update</b>	Download the firmware of the camera body or lens. For information about updating the firmware, refer to page 216.
<b>Manual Download</b>	Download the User Manual.
<b>Samsung Movie Converter</b>	Download this program to convert HEVC files to another format. You can convert HEVC files to other formats (H.264) and edit them in programs that are incompatible with HEVC. Converting UHD videos is supported only on 64-bit editions.
<b>Samsung DNG Converter</b>	Download this program to convert Samsung RAW files (SRW) to DNG files.
<b>PC Auto Backup</b>	i-Launcher provides a link for downloading the PC Auto Backup program when you connect the camera to a computer. You can send photos or videos that you captured with the camera to a PC wirelessly. For information about installing PC Auto Backup, refer to page 176.
<b>Power Media Player</b>	Download this program to play videos in HEVC or H.264 format. This program can be used only on Windows OS.

Item	Description
NX1 SDK Download	<p>Download the NX1 SDK (Samsung Remote Studio, sample source, SDK user manual).</p> <ul style="list-style-type: none"> <li>• <b>Samsung Remote Studio:</b> Connect the camera to your computer via USB to control the camera with your computer. Before connecting the camera to your computer, in Shooting or Playback mode, press [MENU] → ⚙️ → <b>USB Connection</b> → <b>Remote Access</b>. (p. 194)</li> <li>• <b>Sample Source:</b> View the sample source codes to develop SDK.</li> <li>• <b>SDK User Manual:</b> View the description of the SDK API and the SDK's usage information.</li> </ul>

### Requirements

Item	Requirements	
i-Launcher Web PC Auto backup	Windows	Windows 7/8/8.1 Internet Explorer 10 or later
	Mac	Mac OS 10.7 or higher Safari 6 or later
Samsung Movie Converter	Windows	64-bit Windows 7/8/8.1 (32-bit editions support up to Full HD. .NET Framework 4.0 or above is supported with Windows 7.)
	Mac	Mac OS 10.7 or higher
Power Media Player	Windows	Windows 7/8/8.1 Intel® 3rd Gen. i5 3.4 GHz or higher (equivalent AMD processor) Minimum 1 GB RAM 400 MB of available hard-disk space (1 GB and above recommended)
Samsung DNG Converter	Windows	Windows 7/8/8.1
	Mac	Mac OS 10.7/10.8/10.9

## Installing Adobe Photoshop Lightroom

- 1 Insert Adobe Photoshop Lightroom DVD-ROM into your PC.
- 2 Select a language.
- 3 Follow the on-screen instructions.

## Using Adobe Photoshop Lightroom

Photos captured by a camera are often converted to JPEG format and stored in the memory according to the settings of the camera at the time of shooting. RAW files are not converted to JPEG format and are stored in the memory without any changes. With Adobe Photoshop Lightroom, you can calibrate exposures, White Balances, tones, contrasts, and colors of photos. You can also edit JPEG or TIFF files as well as RAW files. For more information, refer to the program guide.



- If you cannot open Samsung RAW files (SRW) with Adobe Photoshop Lightroom, convert the file format to DNG with the Samsung DNG Converter or update the Adobe Photoshop Lightroom program.
- In Adobe Photoshop Lightroom, an image's brightness, color, and other effects may be displayed differently. This occurs because the original camera settings and options applied during image capture are removed to prepare the image for processing by Adobe Photoshop Lightroom.



# Updating the firmware

Connect the camera to the computer and update the firmware of the camera or the lens.



- You cannot run a firmware update without a fully charged battery. Recharge the battery fully before running a firmware update.
- If you update the firmware, user settings and values will be reset. (Date, time, language, and video out will not change.)
- Do not turn the camera off while the update is in progress.

1 In Shooting or Playback mode, press [MENU] → ⚙️ → **USB Connection** → **Mass Storage**. (p. 194)

2 Turn off the camera.

3 Connect your camera to the computer with the USB cable.

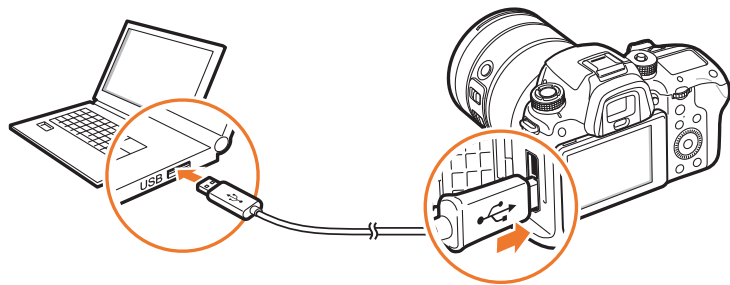

- You must plug the small end of the USB cable into your camera. If the cable is reversed, it may damage your files. The manufacturer is not responsible for any loss of data.
- If you try to plug the USB cable into the HDMI port, the camera may not work properly.
- When using a USB 2.0 cable, plug the USB cable into the lower part of the USB port. If the plug connectors are forced, the device may be damaged. The manufacturer is not responsible for any loss of data.



When using a USB 3.0 cable (optional), connect the USB cable as shown in the illustration.

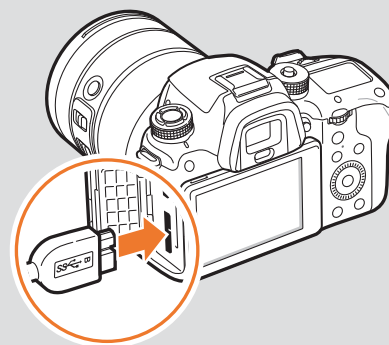

- 4 Turn on the camera.
- 5 On the computer, select **i-Launcher** or **i-Launcher Web** → **Software Update**. (p. 213)
- 6 Follow the on-screen instructions to download the firmware to the camera.
  - You can download the firmware of the camera or the lens.
- 7 Turn off the camera when the download completes.
- 8 Remove the USB cable.
- 9 Turn on the camera.
- 10 Press [MENU] → ⚙ → **Device Information** → **Software Update** → **Body Firmware** or **Lens Firmware**.
- 11 Select **Update** in the pop-up window on the camera to update the firmware.



# Before contacting a service center

If you are having trouble with your device, try these troubleshooting solutions before contacting a service professional.



When you leave your camera at a service center, be sure to also leave the other components that may have contributed to the malfunction, such as the memory card and battery.

Situation	Suggested remedies
<b>Cannot turn on the camera</b>	<ul style="list-style-type: none"> <li>• Ensure that the battery is inserted.</li> <li>• Ensure that the battery is inserted correctly.</li> <li>• Charge the battery.</li> </ul>
<b>The power turns off suddenly</b>	<ul style="list-style-type: none"> <li>• Charge the battery.</li> <li>• Your camera may be in Power save mode or the display turns off automatically. (p. 193)</li> <li>• The camera may be turned off automatically to prevent the memory card from being damaged due to excessive heat. Turn on your camera again.</li> </ul>
<b>The camera is losing battery power quickly</b>	<ul style="list-style-type: none"> <li>• The battery may lose power more quickly in low temperatures (below 0 °C/32 °F). Keep the battery warm by putting it into your pocket.</li> <li>• Using the flash or recording videos depletes the battery quickly. Recharge if needed.</li> <li>• Batteries are consumable parts that must be replaced over time. Get a new battery if the battery life is diminishing quickly.</li> </ul>

Situation	Suggested remedies
<b>Cannot capture photos</b>	<ul style="list-style-type: none"> <li>• There is no space on the memory card. Delete unnecessary files or insert a new card.</li> <li>• Format the memory card.</li> <li>• The memory card is defective. Get a new memory card.</li> <li>• The memory card is locked. Unlock the card. (p. 203)</li> <li>• Ensure that the camera is switched on.</li> <li>• Charge the battery.</li> <li>• Ensure that the battery is inserted correctly.</li> </ul>
<b>The camera freezes</b>	Remove the battery and insert it again.
<b>The camera heats up</b>	While using the camera, it may heat up. This is normal and should not affect your camera's lifespan or performance.
<b>The flash fires unexpectedly</b>	The flash may fire due to static electricity. The camera is not malfunctioning.
<b>The flash does not work</b>	<ul style="list-style-type: none"> <li>• The flash option may be set to <b>Off</b>. (p. 116)</li> <li>• You cannot use the flash in some modes.</li> </ul>
<b>The date and time are incorrect</b>	Set the date and time under the ⚙️ menu. (p. 193)
<b>The display or buttons do not work</b>	Remove the battery and insert it again.

Situation	Suggested remedies
<b>The memory card has an error</b>	<ul style="list-style-type: none"> <li>• Turn off the camera, and then turn it on again.</li> <li>• Remove the memory card, and then insert it again.</li> <li>• Format the memory card.</li> </ul> <p>See “Cautions when using memory cards” for more details. (p. 206)</p>
<b>Your computer does not recognize an SDXC or UHS-I/UHS-II memory card</b>	<p>SDXC memory cards use the exFAT file system. To use SDXC memory cards or UHS-I/UHS-II memory cards that are formatted with the exFAT file system on a Windows XP computer, download and update the exFAT file system driver from the Microsoft website.</p>
<b>Your TV or computer cannot display photos and videos that are stored on an SDXC or UHS-I/UHS-II memory card</b>	<p>SDXC memory cards use the exFAT file system. To use SDXC memory cards or UHS-I/UHS-II memory cards that are formatted with the exFAT file system, ensure that the external device is compatible with the exFAT file system before connecting the camera to the device.</p>
<b>Cannot display files</b>	<p>If you change the name of a file, your camera may not play the file (the name of the file should meet the DCF standard). If you encounter this situation, display files on your computer.</p>

Situation	Suggested remedies
<b>The photo is blurry</b>	<ul style="list-style-type: none"> <li>• Ensure that the focus option you set is suitable for the kind of shot you are capturing.</li> <li>• Use a tripod to prevent your camera from shaking.</li> <li>• Ensure that the lens is clean. If not, clean the lens. (p. 200)</li> </ul>
<b>The colors in the photo do not match the actual scene</b>	<p>An incorrect White Balance can create unrealistic color. Select the proper White Balance option to suit the light source. (p. 94)</p>
<b>The photo is too bright or too dark.</b>	<p>Your photo is overexposed or underexposed.</p> <ul style="list-style-type: none"> <li>• Adjust the aperture value or the shutter speed.</li> <li>• Adjust the ISO sensitivity. (p. 91)</li> <li>• Turn the flash off or on. (p. 116)</li> <li>• Adjust the exposure value. (p. 126)</li> </ul>
<b>Photos are distorted</b>	<p>Minor distortion can occur when you use this camera with a wide angle lens that enables shooting at a wide angle of view. This is normal, and is not a malfunction.</p>
<b>Horizontal lines appear on the photo</b>	<p>This may occur when the subject is illuminated by a fluorescent or mercury-vapor light source. Select a slow shutter speed.</p>

Situation	Suggested remedies
The playback screen does not appear on the connected external device	<ul style="list-style-type: none"> <li>• Ensure that the HDMI cable is properly connected to the external monitor.</li> <li>• Ensure that the memory card has recorded properly.</li> </ul>
Your computer does not recognize your camera	<ul style="list-style-type: none"> <li>• Ensure that the USB cable is connected correctly.</li> <li>• Ensure that the camera is switched on.</li> <li>• Ensure that you are using a supported operating system.</li> <li>• Before connecting the camera to your computer, in Shooting or Playback mode, press [MENU] →  → <b>USB Connection</b> → <b>Mass Storage</b>. (p. 194)</li> </ul>
Your computer disconnects the camera while transferring files	The file transfer may be interrupted by static electricity. Disconnect the USB cable and connect it again.
i-Launcher or i-Launcher Web is not functioning properly	<ul style="list-style-type: none"> <li>• End i-Launcher or i-Launcher Web and restart the program.</li> <li>• Depending on your computer's specifications and environment, the program may not launch automatically. In this case, click <b>Start</b> → <b>All Programs</b> → <b>Samsung</b> → <b>i-Launcher</b> or <b>i-Launcher Web</b> → <b>Samsung i-Launcher</b> or <b>i-Launcher Web</b> on your Windows computer. (For Windows 8, open Start screen, and then select <b>All apps</b> → <b>Samsung i-Launcher</b> or <b>i-Launcher Web</b>.) Or, click <b>Applications</b> → <b>Samsung</b> → <b>i-Launcher</b> or <b>i-Launcher Assistant</b> on your Mac OS computer.</li> </ul>

Situation	Suggested remedies
Auto Focus does not work	<ul style="list-style-type: none"> <li>• The subject is not in focus. When the subject is outside the AF area, focus on the subject by moving it into the AF area and half-pressing [Shutter].</li> <li>• The subject is too close. Step back from the subject and shoot.</li> <li>• The focus mode is set to MF. Switch the mode to AF.</li> </ul>
The AEL feature does not work	The AEL feature does not work in <b>AUTO</b> , <b>M</b> , and <b>S</b> modes. Select another mode to use this feature.
The lens does not work	<ul style="list-style-type: none"> <li>• Ensure that the lens is properly mounted.</li> <li>• Remove the lens from the camera and remount it.</li> </ul>
The external flash does not work	Ensure that the external device is properly mounted and turned on.
The date and time settings screen appears when you power on the camera	<ul style="list-style-type: none"> <li>• Set the date and time again.</li> <li>• This screen appears when the camera's internal power source is completely discharged. Insert a fully charged battery, turn off the camera, and then wait at least 72 hours for the internal power source to recharge.</li> </ul>

# Camera specifications

Image Sensor	
Type	BSI CMOS
Sensor size	23.5 X 15.7 mm
Effective pixels	Approx. 28.2 mega-pixels
Total pixels	Approx. 30.7 mega-pixels
Color filter	RGB primary
Lens Mount	
Type	Samsung NX Mount
Available lens	Samsung NX lenses (3D lens supported)
Image Stabilization	
Type	Lens shift (depends on lens)
Mode	Off/Mode 1/Mode 2
Distortion Correct	
Off/On (depends on lens)	
i-Function	
Aperture value, shutter speed, exposure value, ISO, white balance, intelli-Zoom	

Dust Reduction	
Super sonic drive	
Display	
Type	Super AMOLED with Touch Screen
Size	3.0" (Approx. 76.6 mm)
Resolution	1,036 k dots
Field of view	Approx. 100 %
Guide display	Yes
Viewfinder	
Type	Electronical viewfinder (OLED) (Eye Contact Sensor)
Resolution	XGA 2,360 k dots
Field of view	Approx. 100 %
Magnification	Approx. 1.04 X (APS-C, 50 mm, -1 m <sup>-1</sup> )
Eyepoint	Approx. 21.0 mm
Diopter adjustment	Approx. -4.0–+2.0 m <sup>-1</sup>

Focusing	
Type	Hybrid AF
Focusing point	<ul style="list-style-type: none"> <li>Total AF point: 205 points (Phase Detection AF), 209 points (Contrast AF)</li> <li>AF Range: EV -4–20</li> </ul>
Mode	Active AF, Single AF, Continuous AF, Manual Focus
AF Assist Lamp	Yes
Shutter	
Speed	<ul style="list-style-type: none"> <li>Auto: 1/8,000 sec.–1/4 sec.</li> <li>Manual: 1/8,000 sec.–30 sec.</li> <li>Bulb</li> </ul>
Exposure	
Metering system	TTL 221 Block segment Metering: Multi, Center-weighted, Spot
Compensation	Still: ±5 EV, Movie: ±3 EV (1/3 EV Step)
ISO equivalent	Auto, 100–25600 (1 EV or 1/3 EV Step) * You can expand up to ISO 51200.

Drive Modes	
Mode	Single, Continuous, Timer, Bracket
Continuous shooting	15 fps
Bracket shooting	Auto exposure bracketing, White Balance bracketing, Picture Wizard bracketing, Depth bracketing
Self-timer	2–30 sec. (1 second interval)
Flash	
Type	Built-in flash
Mode	Smart Flash, Auto, Auto Red-eye, Fill in, Fill-in Red, 1st Curtain, 2nd Curtain, Off
Guide number	11 (based on ISO 100)
Angle of view	28 mm (35 mm film equivalent)
Sync speed	Less than 1/250 sec.
Flash EV	-2–+2 EV (1/3 EV Step), FEL
External flash	Optional Samsung external flashes
Sync terminal	Hot-shoe

White Balance	
<b>Mode</b>	Auto WB, Daylight, Cloudy, Fluorescent White, Fluorescent NW, Fluorescent Daylight, Tungsten, Tungsten (Auto), Flash WB, Custom Set, Color Temperature (Manual)
<b>Micro adjustment</b>	Amber/Blue/Green/Magenta 7 steps respectively
Dynamic Range Expansion	
Off/Smart Range+/HDR	
Effects	
<b>Picture wizard</b>	Standard, Vivid, Portrait, Landscape, Forest, Retro, Cool, Calm, Classic, Custom1, Custom2, Custom3
<b>Smart filter</b>	Vignetting, Miniature (H), Miniature (V), Watercolor, Selective Color (R/G/B/Y 4 Colors)
Photos	
<b>Mode</b>	Auto, Program, Aperture Priority, Shutter Priority, Manual, Custom1, Custom2, Smart
<b>Smart mode</b>	Beauty Face, Landscape, Action Freeze, Rich Tones, Panorama, Waterfall, Silhouette, Sunset, Night, Fireworks, Light Trace, Multi Exposure, Samsung Auto Shot

<b>Size</b>	<ul style="list-style-type: none"> <li>• JPEG (3:2): 28M (6480X4320), 13.9M (4560X3040), 7.1M (3264X2176), 3M (2112X1408)</li> <li>• JPEG (16:9): 23.6M (6480X3648), 11.9M (4608X2592), 6.2M (3328X1872), 2.4M (2048X1152)</li> <li>• JPEG (1:1): 18.7M (4320X4320), 9.5M (3088X3088), 4.7M (2160X2160), 2M (1408X1408)</li> <li>• RAW: 28M (6480X4320)</li> </ul>
<b>Quality</b>	Super Fine, Fine, Normal
<b>Color space</b>	sRGB, Adobe RGB
Video	
<b>Format</b>	MP4 (HEVC), AVI (MJPEG)
<b>Compression</b>	Movie: HEVC (H.265), MJPEG (VGA 30p only), Sound: AAC (MP4), Linear PCM (AVI)
<b>Movie AE mode</b>	Auto, Program, Aperture Priority, Shutter Priority, Manual, Custom1, Custom2, Smart
<b>Size</b>	4096X2160 (24 fps only), 3840X2160 (30 fps only), 1920X1080, 1280X720, 640X480
<b>Frame rate</b>	<ul style="list-style-type: none"> <li>• NTSC: 60 fps, 30 fps, 24 fps, 23.98 fps</li> <li>• PAL: 50 fps, 25 fps, 24 fps</li> </ul>



<b>Fast / Slow Movie</b>	x0.25 (1920X1080 30p/25p, 1280X720 30p/25p, 640X480 30p/25p only), x0.5 (1920X1080 60p/50p/30p/25p, 1280X720 60p/50p/30p/25p, 640X480 60p/50p/30p/25p only), x5, x10, x20
<b>Quality</b>	HQ, Normal, Pro (4096X2160, 3840X2160, 1920X1080 only)
<b>Sound</b>	Stereo
<b>Playback</b>	
<b>Type</b>	Single image, Thumbnails (15/24), Slide show, Movie
<b>Editing</b>	
<b>Photos</b>	Edit, Color, Portrait, Smart Filter
<b>Movie</b>	Still image capture, Time trimming
<b>Memory</b>	
<b>External media</b>	SD card, SDHC card, SDXC card (up to 64 GB guaranteed), UHS-I, UHS-II Supported
<b>Network and Wireless Connectivity</b>	
<b>Wi-Fi</b>	IEEE 802.11b/g/n/ac
<b>NFC</b>	Yes
<b>Connectivity support</b>	Bluetooth

<b>Interface</b>	
<b>Digital output connector</b>	USB 3.0
<b>Video output</b>	HDMI (NTSC, PAL)
<b>External release</b>	Yes
<b>USB</b>	Yes
<b>Audio</b>	3.5 mm stereo MIC input, 3.5 mm stereo output
<b>Battery</b>	
<b>Capacity</b>	1,860 mAh
<b>Charging</b>	DC 5.0 V, 2 A via Micro USB port
<b>Still image capturing time</b>	500 shots (CIPA Standard)
<b>Physical Specifications</b>	
<b>Dimensions (W X H X D)</b>	5.5 X 4 X 2.6 in (138.5 X 102.3 X 65.8 mm)
<b>Weight (body only)</b>	Approx. 19.5 oz (550 g)
<b>Operating Environment</b>	
<b>Operating Temperature</b>	32–104 °F (0–40 °C)
<b>Operating Humidity</b>	5–85 %

**Software**

i-Launcher (Web version included), Adobe Photoshop Lightroom 5, Samsung DNG Converter, Samsung Movie Converter, Power Media Player, Samsung Remote Studio

**System Requirements**

<b>Windows</b>	Windows 7/8/8.1, Intel® 3rd Gen. i5 3.4 GHz or higher (equivalent AMD processor)
<b>Macintosh</b>	Mac OS 10.7 or higher

\* Specifications may change without notice to improve performance.

\* Other brands and products names are trademarks of respective owners.



## **Anaglyph mode**

Anaglyph mode enables a 3D effect to be applied to images when they are viewed through optical devices such as special glasses. The camera captures two separate images in red and cyan (chromatically opposite colors). The images are combined and when viewed through special glasses, with red and cyan colored filters, a 3D effect is achieved.

## **AP (Access Point)**

An access point is a device that allows wireless devices to connect to a wired network.

## **Ad-Hoc network**

An ad-hoc network is a temporary connection for sharing files or an internet connection and between computers and devices.

## **AdobeRGB**

Adobe RGB is used for commercial printing and has a larger color range than sRGB. Its wider range of colors helps you easily edit photos on a computer.

## **AEB (Auto Exposure Bracket)**

This feature automatically captures several images at different exposures to help you capture a properly-exposed image.

## **AEL/AFL (Auto Exposure Lock/Auto Focus Lock)**

These features help you to lock the exposure or focus settings for a subject.

## **AF (Auto Focus)**

A system that automatically focuses the camera lens on the subject. Your camera uses contrast to focus automatically.

## **AMOLED (Active-matrix organic light-emitting diode)/ LCD (Liquid Crystal Display)**

AMOLED is a very thin and light visual display that does not require backlighting. LCD is a visual display commonly used in consumer electronics. An LCD display needs a separate backlight, such as CCFL or LED lights, to reproduce colors.

## Aperture

The aperture controls the amount of light that reaches the camera's sensor.

## Bluetooth

This feature allows you to exchange files with other devices.

## Camera shake (Blur)

If the camera is moved while the shutter is open, the entire image may appear blurred. This occurs more often when the shutter speed is slow. Prevent camera shake by raising the sensitivity, using the flash, or using a faster shutter speed. Alternatively, use a tripod or the OIS function to stabilize the camera.

## Cloud Computing

Cloud computing is a technology that allows you to store data on remote servers and to use it from a device with Internet access.

## Color space

The range of colors that the camera can identify and reproduce in photos.

## Color temperature

Color Temperature is a measurement in degrees Kelvin (K) that indicates the hue of a specific type of light source. As the color temperature increases, the color of the light source has a more bluish quality. As the color temperature decreases, the color of the light source has a more reddish quality. At 5,500 degrees Kelvin, the color of the light source is similar to the sun at midday.

## Composition

Composition in photography means arranging objects in a photo. Usually, abiding by the rule of thirds leads to a good composition.

## DCF (Design rule for Camera File system)

A specification that defines a file format and file system for digital cameras created by the Japan Electronics and Information Technology Industries Association (JEITA).

## Depth of field

The distance between the nearest and farthest points that can be acceptably focused in a photograph. Depth of field varies with lens aperture, focal length, and distance from the camera to the subject. Selecting a smaller aperture, for example, will increase the depth of field and blur the background of a composition.

## Electronic first curtain shutter

The sensor acts as the first curtain of the shutter. With this function, the shutter reacts faster because no process is needed to operate the mechanical curtain.

## EV (Exposure Value)

All the combinations of the camera's shutter speed and lens aperture that result in the same exposure.

## EV Compensation

This feature allows you to quickly adjust the exposure value measured by the camera, in limited increments, to improve the exposure of your photos.

## Exif (Exchangeable Image File Format)

A specification that defines an image file format for digital cameras created by the Japan Electronic Industries Development Association (JEIDA).

## Exposure

The amount of light allowed to reach the camera's sensor. Exposure is controlled by a combination of the shutter speed, the aperture value, and ISO sensitivity.

## Flash

A speed light that helps to create adequate exposure in low-light conditions.

## Focal length

The distance from the middle of the lens to its focal point (in millimeters). Longer focal lengths result in narrower angles of view and the subject is magnified. Shorter focal lengths result in wider angles of view.

## Histogram

A graphical representation of the brightness of an image. The horizontal axis represents the brightness and the vertical axis represents the number of pixels. High points at the left (too dark) and right (too bright) on the histogram indicate a photo that is improperly exposed.

## HEVC

High-efficiency Video Coding format, established by the international standard organizations ISO-IEC and ITU-T. This codec is capable of providing good video quality at low bit rates.

## Image sensor

The physical part of a digital camera that contains a photosite for each pixel in the image. Each photosite records the brightness of the light that strikes it during an exposure. Common sensor types are CCD (Charge-coupled Device) and CMOS (Complementary Metal Oxide Semiconductor).

## IP (Internet protocol) address

An IP address is a unique number that is assigned to every device that is connected to the internet.

## ISO sensitivity

The sensitivity of the camera to light, based on the equivalent film speed used in a film camera. At higher ISO settings, the camera can use a higher shutter speed to reduce blur caused by camera shake and low light. However, images with a high ISO setting are more susceptible to noise.

## JPEG (Joint Photographic Experts Group)

A lossy method of compression for digital images. JPEG images are compressed to reduce their overall file size with minimal deterioration of the image resolution.

## Metering

The metering refers to the way in which the camera measures the quantity of light to set the exposure.

## MF (Manual Focus)

A system that manually focuses the camera lens on the subject. You can use the focus ring to focus on a subject.

### **MJPEG (Motion JPEG)**

A video format which is compressed as a JPEG image.

### **MPO (Multi Picture Object)**

An image file format that contains multiple images in a file. An MPO file provides a 3D effect on MPO-compatible displays, such as 3D TVs or 3D monitors.

### **Noise**

Misinterpreted pixels in a digital image that may appear as misplaced or random, bright pixels. Noise usually occurs when photos are shot with a high ISO setting or when the sensitivity is automatically set in a dark place.

### **NFC (Near Field Communication)**

NFC is a set of standards for radio communication at very close proximity. You can use NFC-enabled devices to activate features or exchange data with other devices.

### **NTSC (National Television System Committee)**

A video color encoding standard used most commonly in Japan, North America, the Philippines, South America, South Korea, and Taiwan.

### **Optical zoom**

This is a general zoom which can enlarge images with a lens and does not reduce the quality of images.

### **PAL (Phase Alternate Line)**

A video color encoding standard used in numerous countries throughout Africa, Asia, Europe, and the Middle East.

### **Quality**

An expression of the rate of compression used in a digital image. Higher quality images have a lower rate of compression, which usually results in a larger file size.

### **RAW (CCD raw data)**

The original, unprocessed data, collected directly from the camera's image sensor. White Balance, contrast, saturation, sharpness, and other data can be manipulated with editing software before the image is compressed into a standard file format.

### **Resolution**

The number of pixels present in a digital image. High resolution images contain more pixels and typically show more detail than low resolution images.

### **Shutter speed**

Shutter speed refers to the amount of time it takes to open and close the shutter. It is an important factor in the brightness of a photo, as it controls the amount of light which passes through the aperture before it reaches the image sensor. A fast shutter speed allows less time to let in light. The photo becomes darker, but subjects in motion freeze more easily.

### **sRGB (Standard RGB)**

International standard of color space established by the IEC (International Electrotechnical Commission). This is the defined color space for PC monitors and is also used as the standard color space for Exif.

### **Vignetting**

A reduction of an image's brightness or saturation at the periphery (outer edges) compared to the center of the image. Vignetting can draw interest to subjects positioned in the center of an image.

### **White Balance (Color balance)**

An adjustment of the intensities of colors (typically the primary colors red, green, and blue), in an image. The goal of adjusting the White Balance, or color balance, is to correctly render the colors in an image.

### **Wi-Fi**

Wi-Fi is a technology that allows electronic devices to exchange data wirelessly over a network.

### **WPS (Wi-Fi Protected Setup)**

WPS is a technology that secures wireless home networks.



# Optional accessories

You can purchase the following optional items:

Lens, external flash, shutter release (micro USB type), vertical grip, external microphone, rechargeable battery, battery charger, camera bag, camera case, memory card, filter, USB cable, HDMI cable, and camera strap.



- For information about accessories and their availability, visit the Samsung website.
- Before purchasing accessories, make sure they are compatible with your camera.
- Use only Samsung-approved accessories. Samsung is not responsible for damage caused by using another manufacturer's accessories.



**A**

Accessories 232  
Active AF 100  
Adobe Photoshop Lightroom 215  
AEL 128  
Aperture 17, 21  
Auto Backup 176  
Auto focus 98

**B**

Battery  
  Caution 207  
  Charging 39  
  Insert 37  
Bracketing 112

**C**

Camera  
  Disconnecting (Windows) 179  
  Layout 31  
Camera specifications 221  
Color space 183  
Connecting to a computer  
  Auto Backup 176  
  Connecting as removable disk 178  
  Mac OS 180  
  Windows OS 178  
Connecting to a smart phone  
  MobileLink 156  
  QuickTransfer 161  
  Remote Viewfinder 158  
Connecting to a TV  
  3DTV 175  
  TV 174  
  TVLink 172  
Continuous shooting 111

**D**

Date & Time 193  
Depth of Field (DOF) 18, 23  
Display brightness 192  
Display type 55  
Drive 110  
  
**E**  
Email 168  
Enlarging 144  
Error messages 199  
Exposure Value (EV) 17, 126

**F**

Fader 136  
FEL 121  
Files  
  Deleting 143  
  Extension 131  
  Format 90  
  Protecting 142  
Flash  
  Bounce photography 28  
  Flash options 116  
  Guide number 27  
  Intensity 118  
F-number 17  
Focal length 22  
Focus assist 106  
Focus Peaking 108

## I

### Icons

- Playback mode 54
- Shooting mode 50

### i-Launcher 211

### Image adjustment

- Adjusting photos 152
- Retouching faces 152

### Initial settings 41

### Interval capture 115

### ISO 20, 21, 91

### ISO sensitivity 91

## L

### Lenses

- Layout 58
- Locking 59
- Markings 62
- Unlocking 60

## M

### Maintenance 200

### Memory card

- Caution 203
- Insert 37

### Metering 122

### MF Assist 106

### MobileLink 156

## N

### NFC 155

### Notification panel 57

## O

### One touch shot 105

### Optical Image Stabilization (OIS) 109

### Optional accessories

- Connect the flash 65
- Flash layout 63

## P

### Panorama mode 81

### Photos

- Editing 150
- Enlarging 144
- Shooting options 89
- Viewing on camera 139

### Picture Wizard 96

### Posture 14

### Power save mode 193

## Q

### Quick Transfer 161

## R

### Red-eye effect 117

### Remote Viewfinder 158

### Resolution

- Playback mode 151
- Shooting mode (Movie) 130
- Shooting mode (Photo) 89

### Rotating 151

### Rule of thirds 25

## S

**Service center** 218

**Settings** 192

**Shooting modes**

Aperture Priority 74

Auto 70

Custom 77

Manual 76

Program 72

Recording 84

Shutter Priority 75

Smart 79

**Shutter speed** 19, 21

**Slide show** 145

**Smart filter**

Playback mode 153

Shooting mode 97

**Smart panel** 46

**Smart Range+** 137

**Status display window** 56

## T

**Thumbnails** 139

**Time Lapse** 115

**Timer** 112

**Touch AF** 104

**Touch screen** 44

**Tracking AF** 104

**Transferring files**

Mac 180

Windows 178

**TV Link** 172

## U

**Unpacking** 30

## V

**Video Out** 193

**Videos**

Capturing 149

Options 130

Recording 84

Viewing 147

## W

**White balance** 94

**Wireless network** 163

## 3

**3D mode** 86



Please refer to the warranty that came with your product  
or visit our website [www.samsung.com](http://www.samsung.com) for after-sales service or inquiries.

